

MAY 17 1984

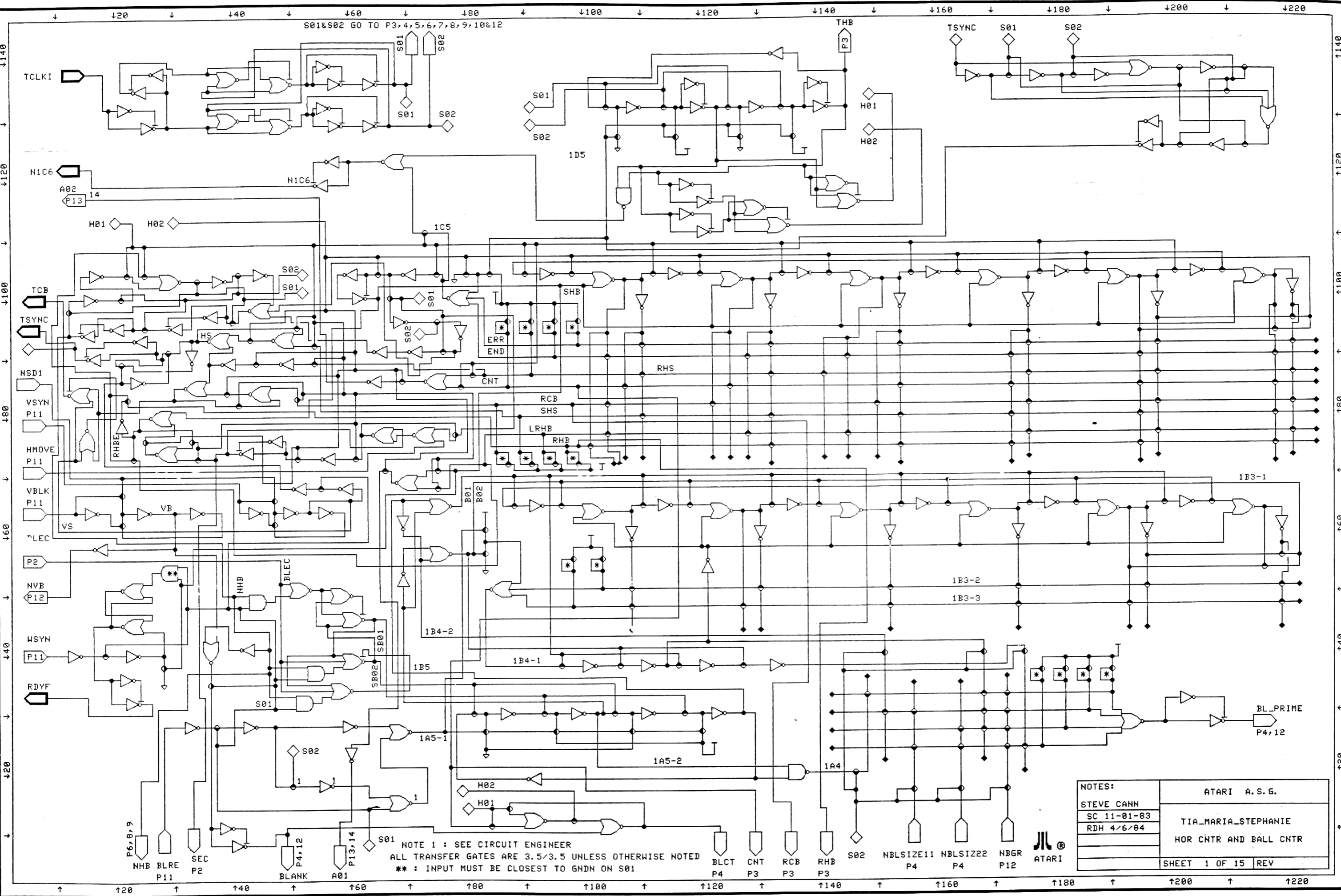

NOTES:		ATARI A.S.G.	
STEVE CANN	SC 11-01-83	TIA_MARIA_STEPHANIE	
	RDH 4/6/84	HOR CNTR AND BALL CNTR	
		SHEET 1 OF 15	REV

16 MAY 84 16:54 USER:BOB/TIA-MARIA-STEPHANIE I. DRAN

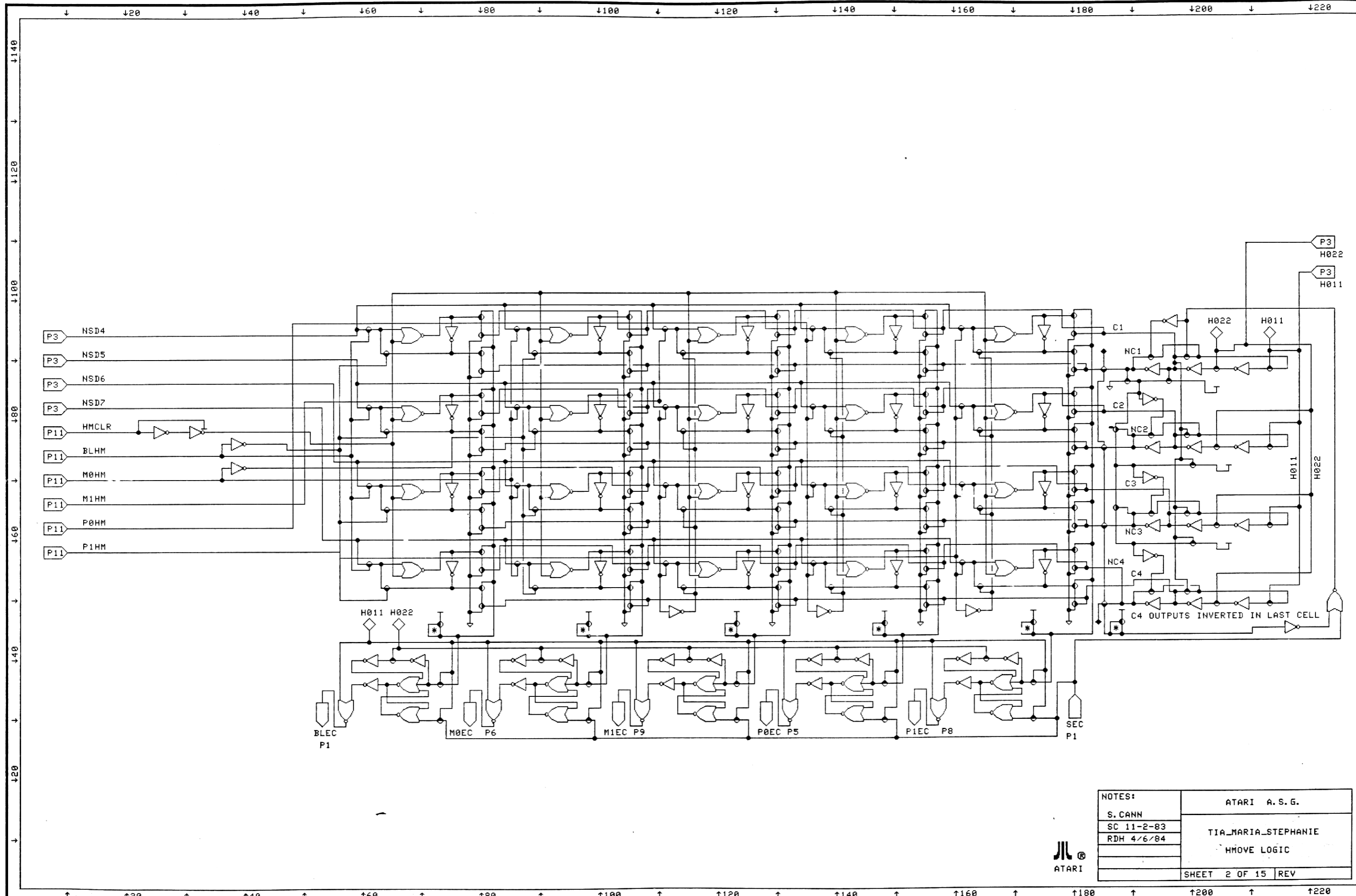

NOTES:	ATARI A. S. G.
S. CANN	TIA_MARIA_STEPHANIE
SC 11-2-83	HMOVE LOGIC
RDH 4/6/84	
	SHEET 2 OF 15 REV



16 MAY 84 18:55 USER:BOB/TIA-MARIA-STEPHANIE 2. DRAM

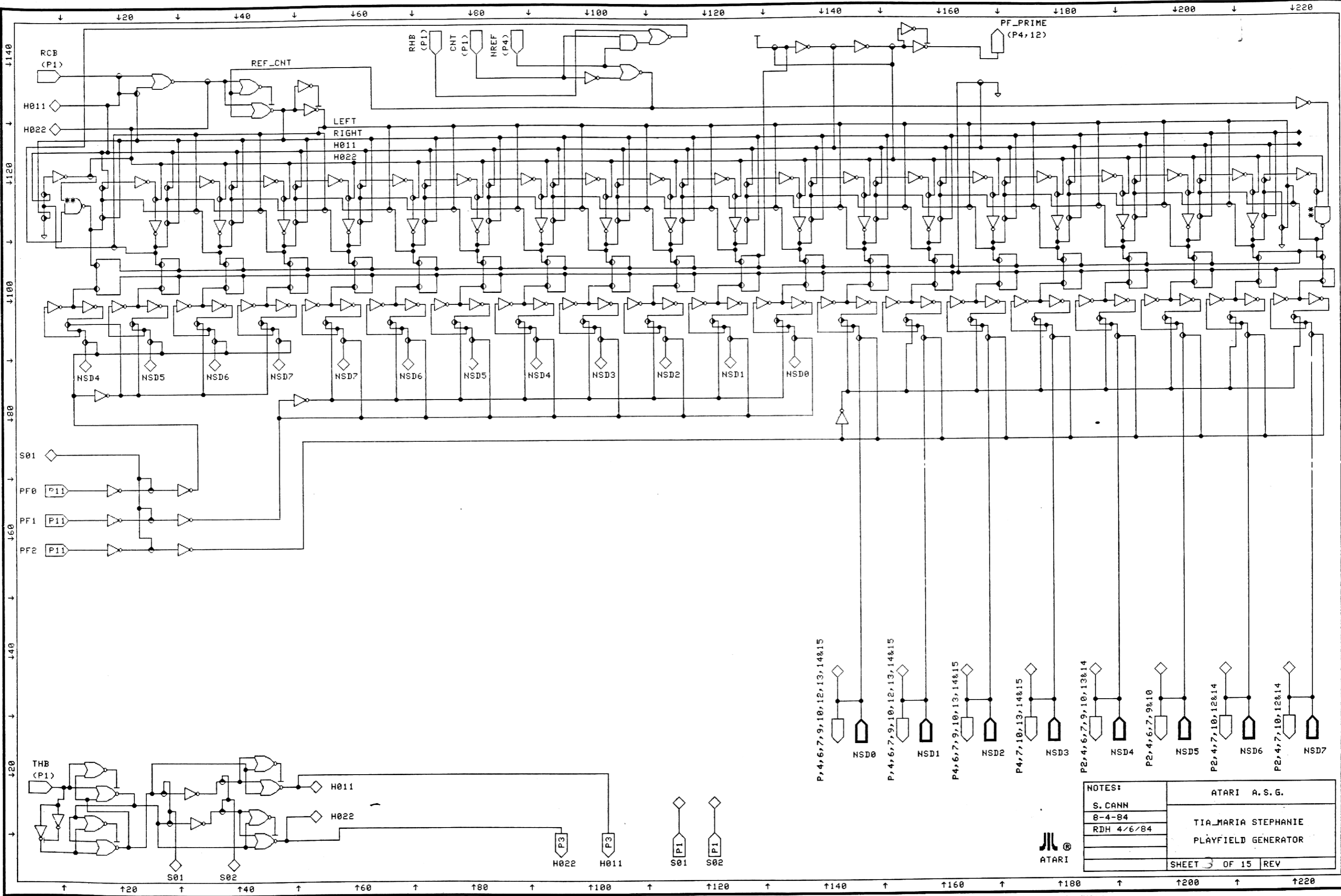

NOTES:	ATARI A. S. G.
S. CANN	TIA MARIA STEPHANIE PLAYFIELD GENERATOR
8-4-84	
RDH 4/6/84	
	SHEET 3 OF 15 REV



16 MAY 84 16157 USER:BOB/TIA-MARIA-STEPHANIE 3.DRAW

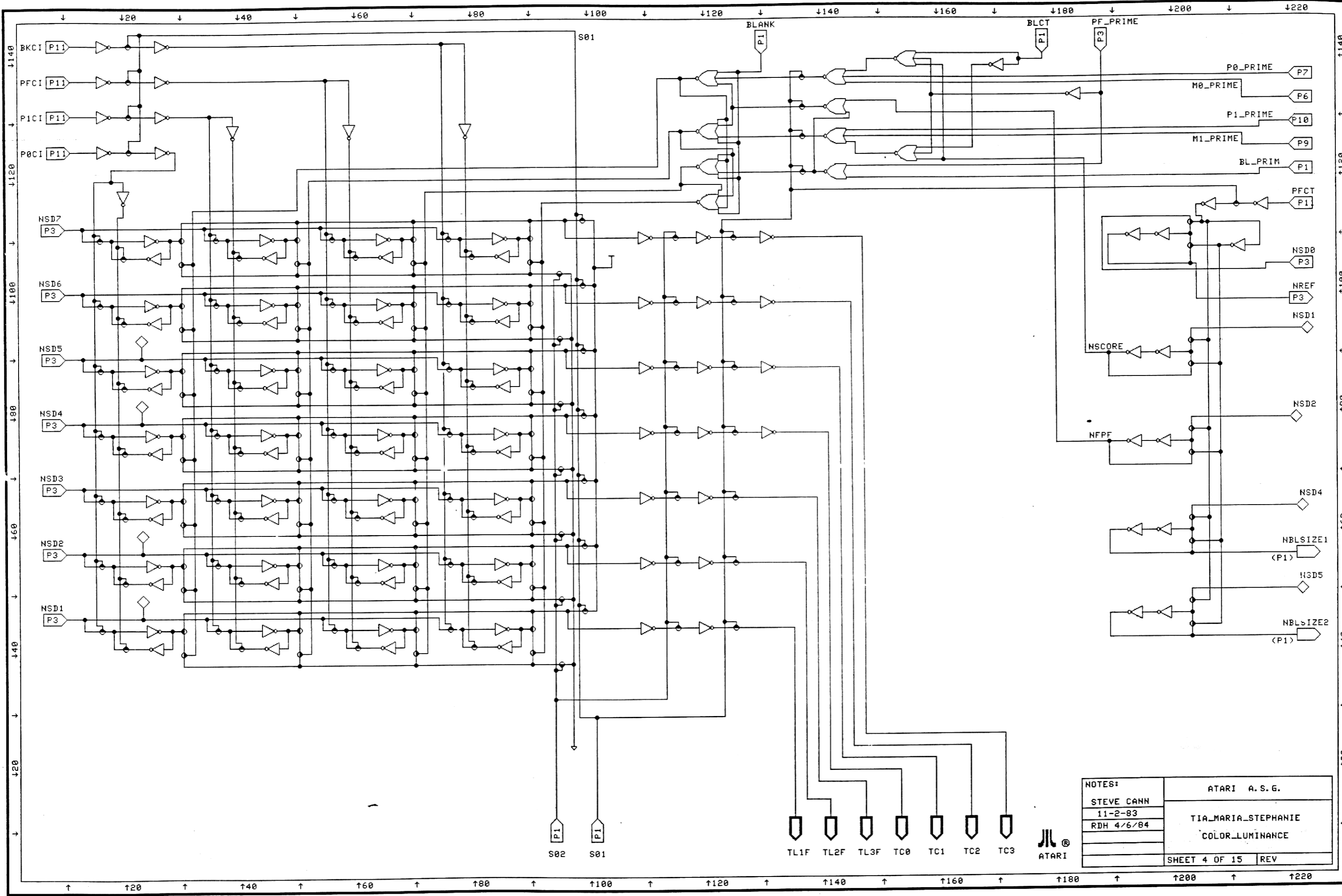

NOTES:	ATARI A. S. G.
STEVE CANN	TIA_MARIA_STEPHANIE
11-2-83	COLOR_LUMINANCE
RDH 4/6/84	SHEET 4 OF 15
	REV

16 MAY 84 181587 USER/BOB/TIA-MARIA/STEPHANIE 4. DRAM

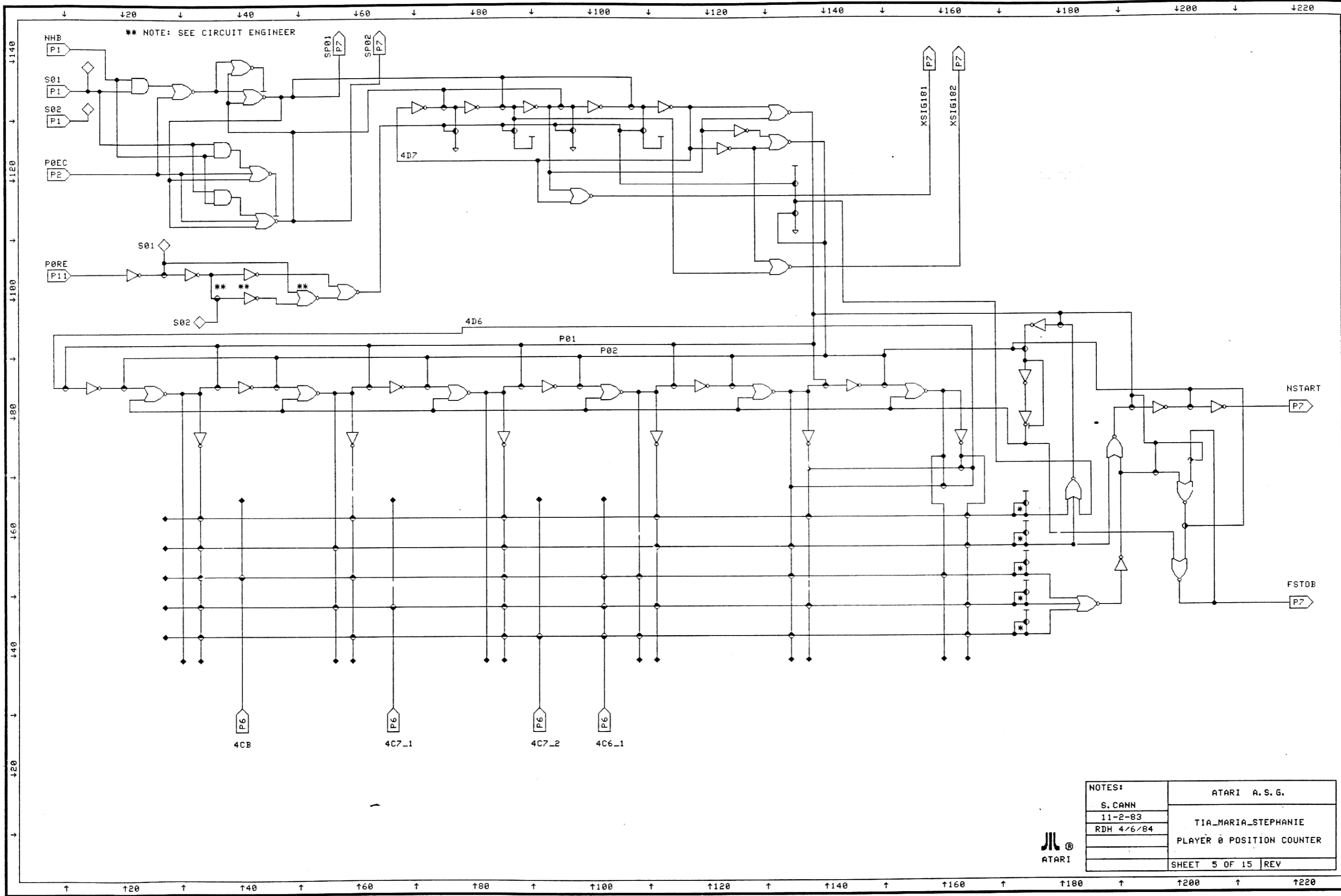

NOTES:	ATARI A. S. G.
S. CANN	TIA_MARIA_STEPHANIE
11-2-83	PLAYER 0 POSITION COUNTER
RDH 4/6/84	SHEET 5 OF 15   REV

16 MAY 84 19:00 / USER:BOB / TIA-MARIA-STEPHANIE 5. DRAN

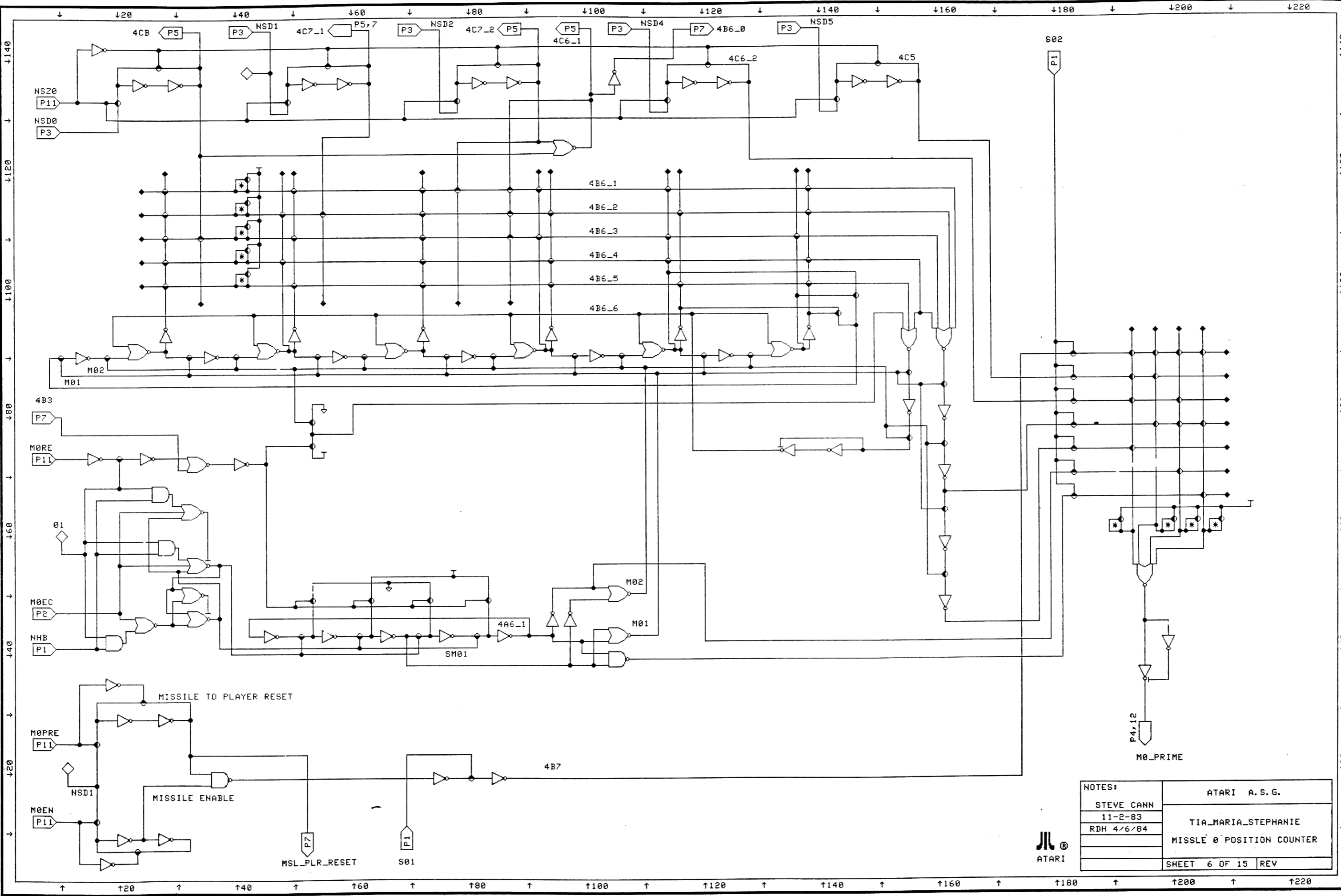

NOTES:	STEVE CANN	ATARI A.S.G.
	11-2-83	TIA_MARIA_STEPHANIE
	RDH 4/6/84	MISSILE 0 POSITION COUNTER
		SHEET 6 OF 15   REV



16 MAY 84 19:02 ZUSER2BOB/TIA-MARIA/STEPHANIE 6. DRAD

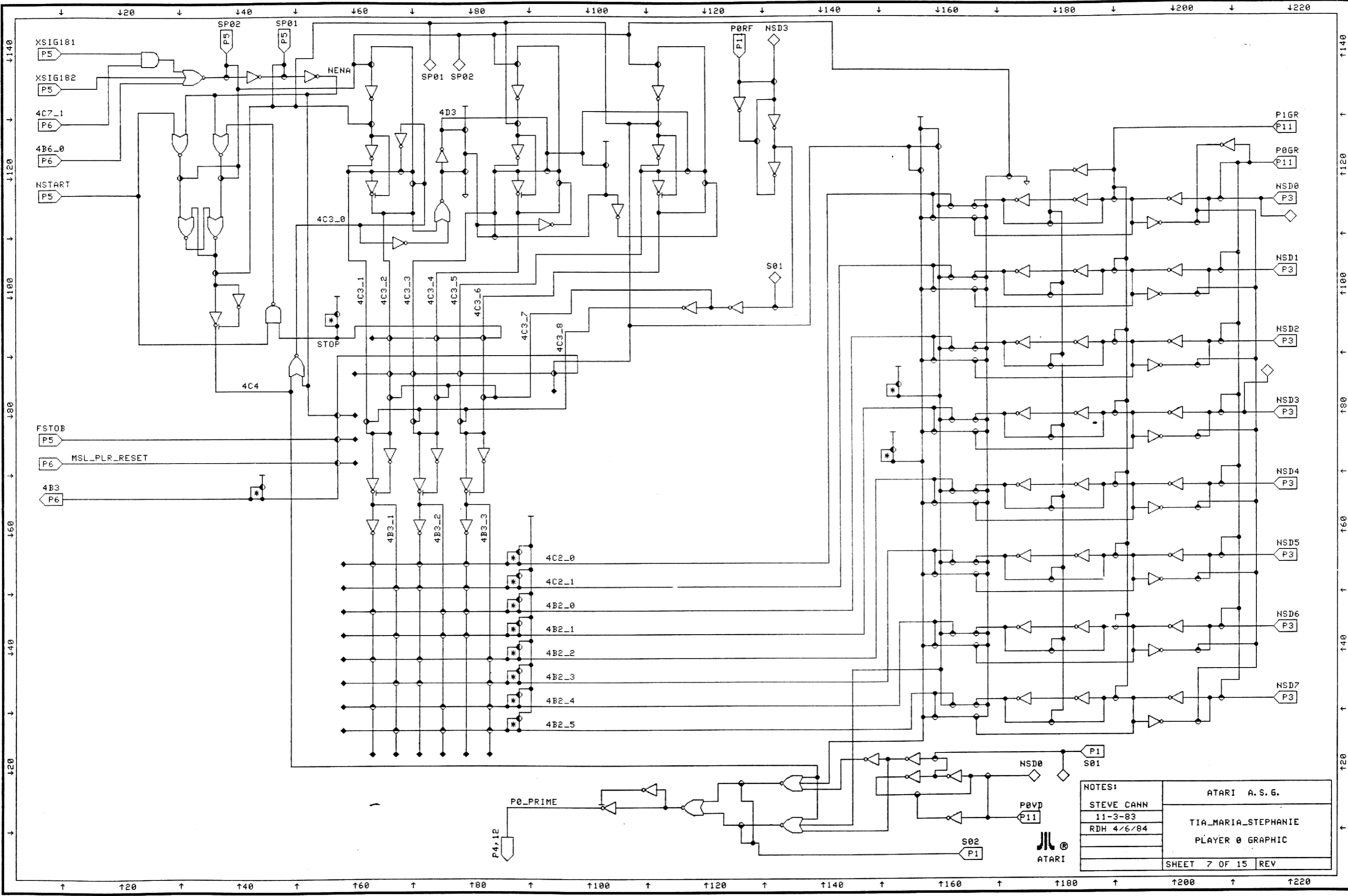

NOTES: STEVE CANN 11-3-83 RDH 4/6/84	ATARI A.S.G.
	TIA_MARIA_STEPHANIE PLAYER 0 GRAPHIC
	SHEET 7 OF 15 REV

16 MAY 84 19:03 USER:BOB/TIA-MARIA-STEPHANIE 7.DRAW

\*\* NOTE: SEE CIRCUIT ENGINEER

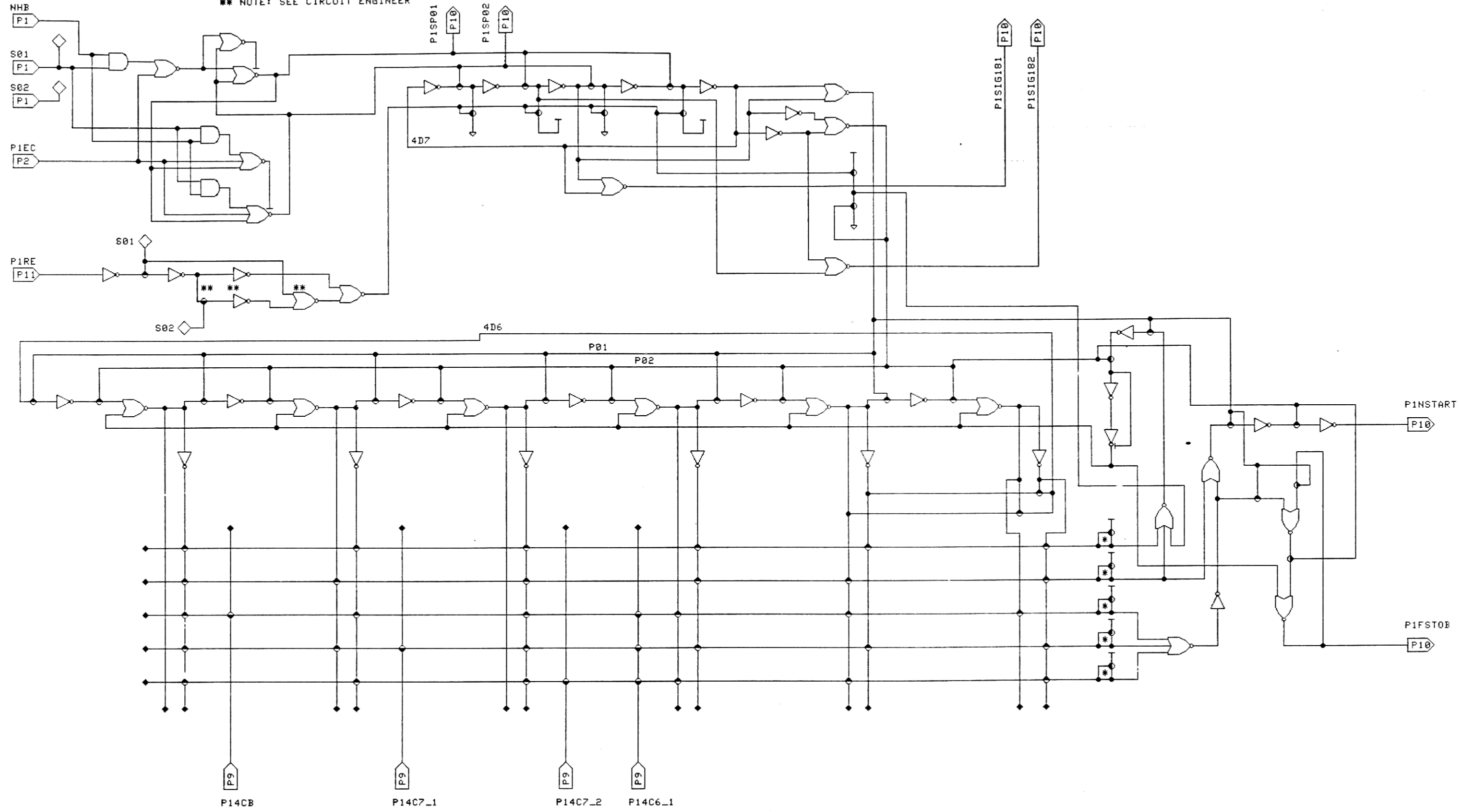

NOTES:	ATARI A.S.G.
S. CANN	TIA_MARIA_STEPHANIE
11-2-83	P1 POSITION COUNTER
RDH 4/6/84	
	SHEET 8 OF 15
	REV



15 MAY 84 19:05 / USER: BOB / TIA-MARIA-STEPHANIE 8. DRAM



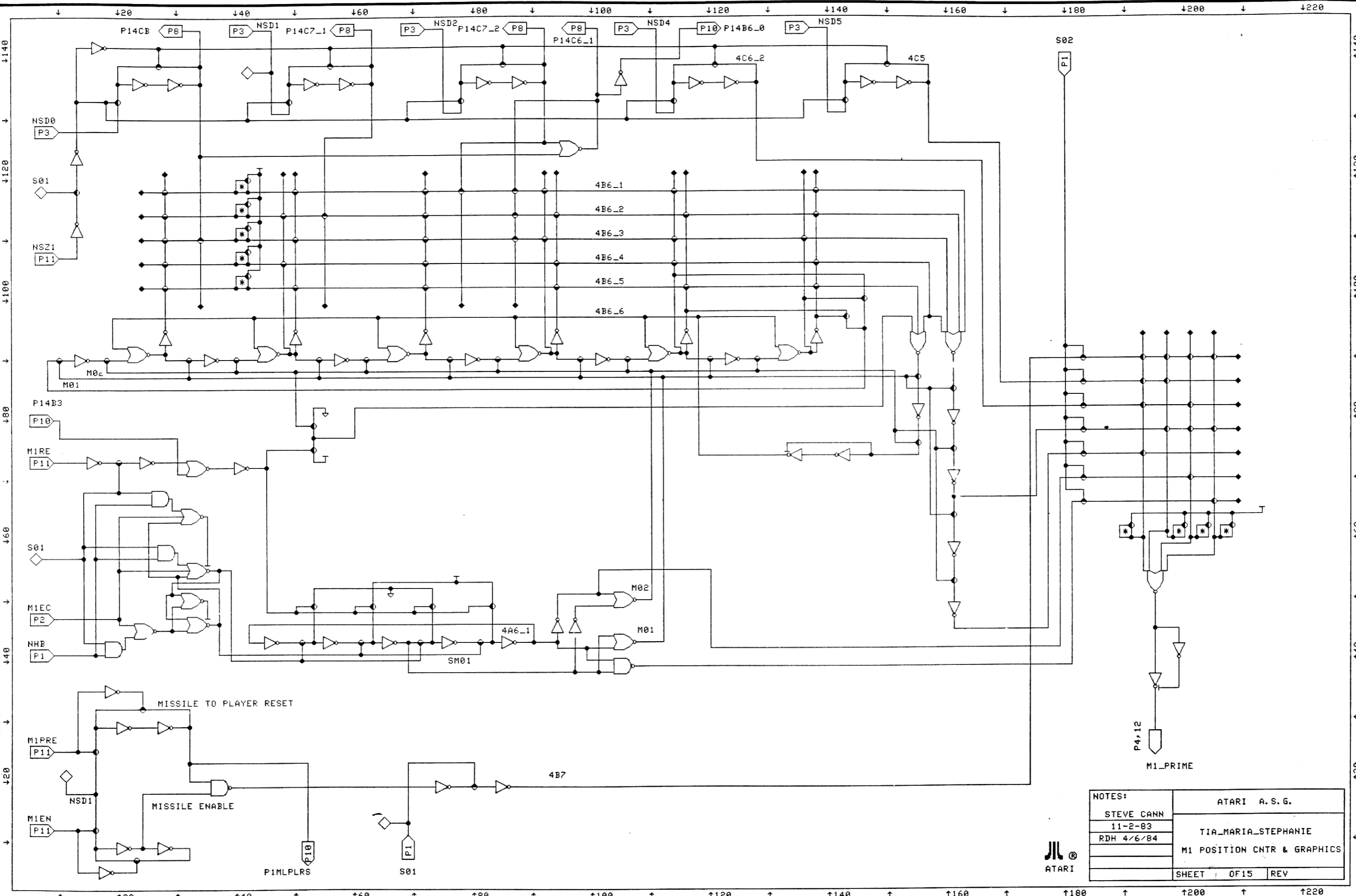

NOTES: STEVE CANN 11-2-83 RDH 4/6/84	ATARI A.S.G.	
	TIA_MARIA_STEPHANIE	
	M1 POSITION CNTR & GRAPHICS	
	SHEET	OF 15



16 MAY 84 19:06 USER:BOB7/TIA-MARIA/STEPHANIE 9. DRAM

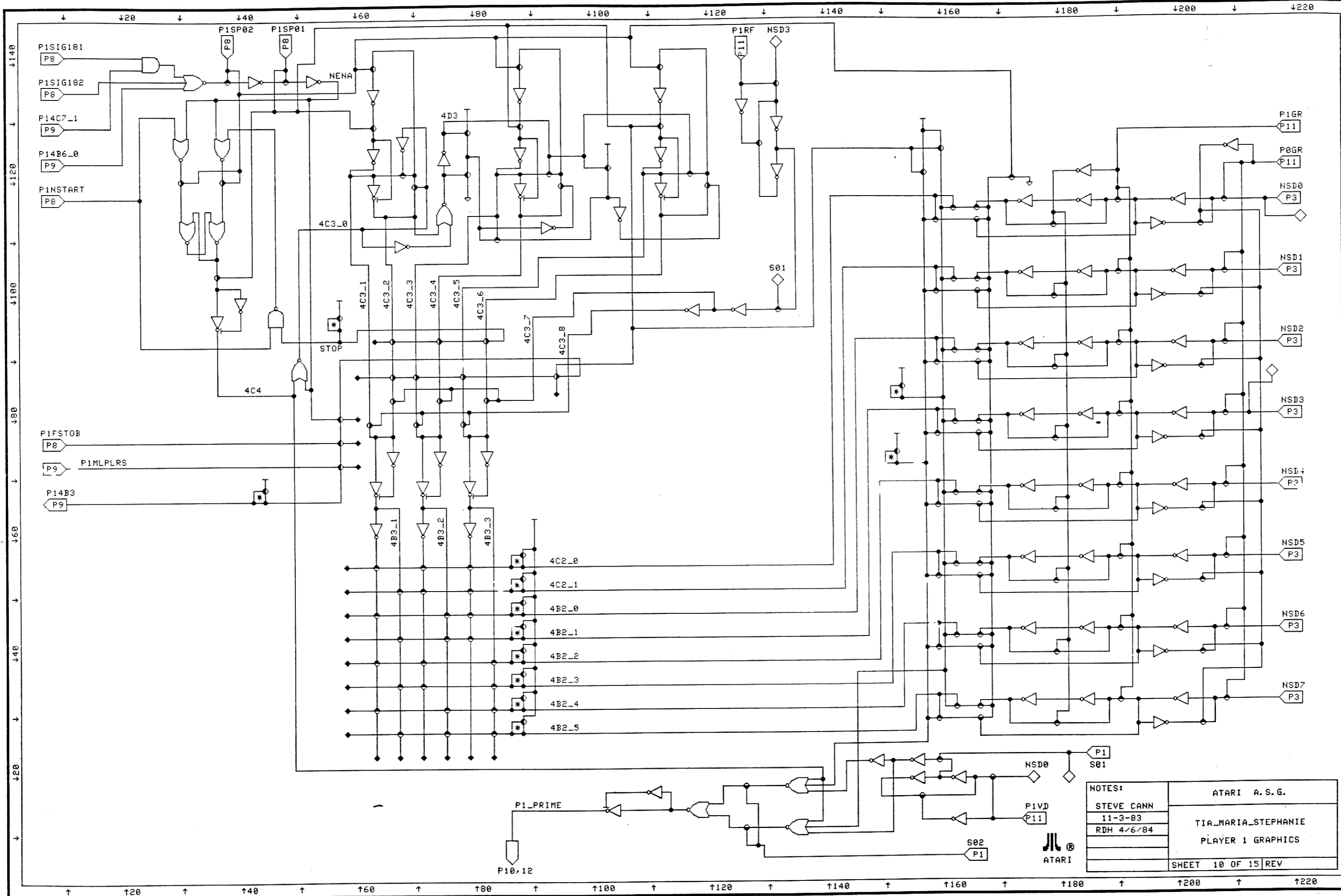

NOTES:	STEVE CANN	ATARI A. S. G.
	11-3-83	
	RDH 4/6/84	
	TIA_MARIA_STEPHANIE	PLAYER 1 GRAPHICS
	SHEET 10 OF 15 REV	

16 MAY 84 19:08 USER:BOB/TIA-MARIA-STEPHANIE 10.DRAW

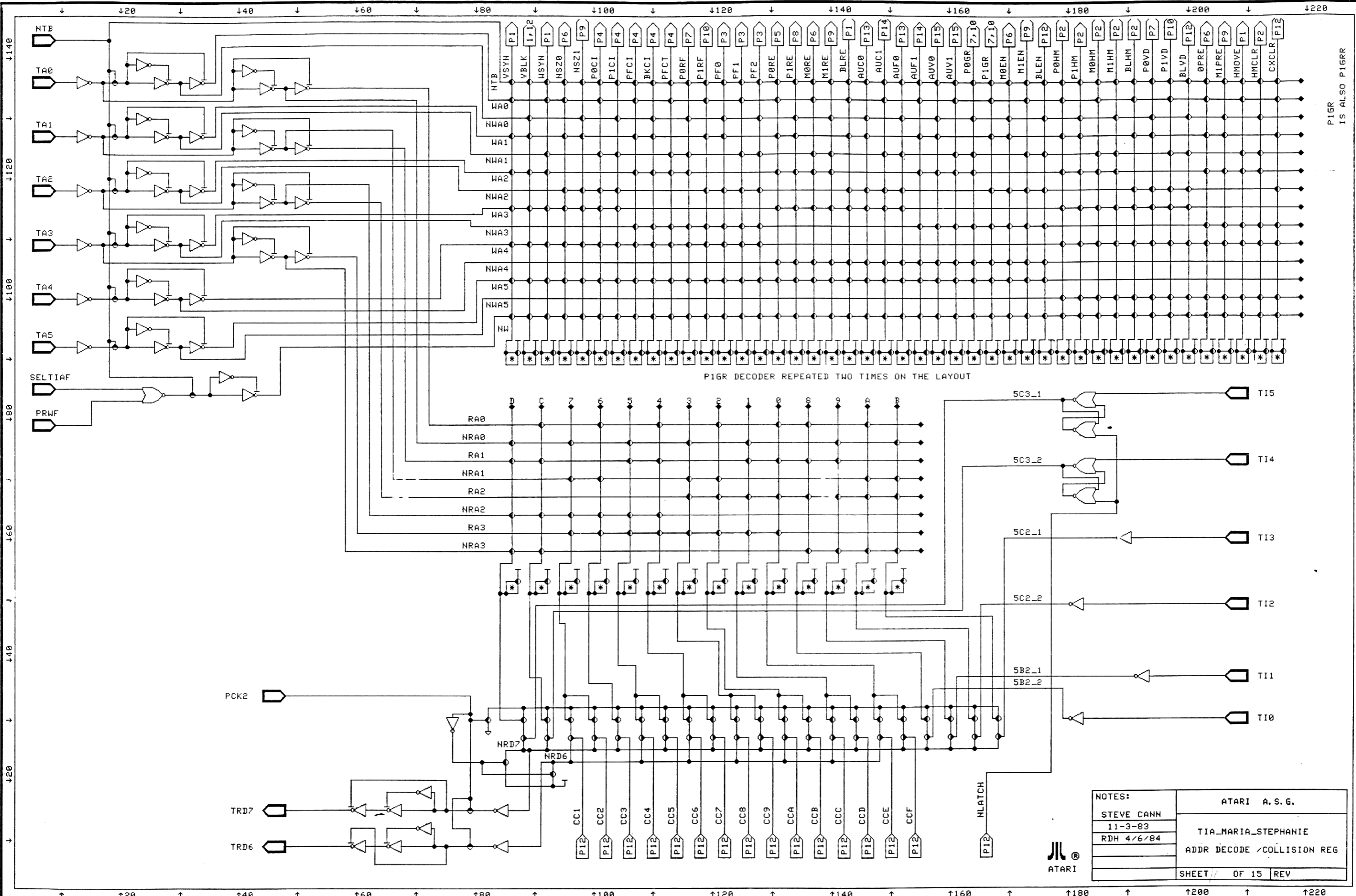

P1GR DECODER REPEATED TWO TIMES ON THE LAYOUT

NOTES:		ATARI A. S. G.	
STEVE CANN		TIA_MARIA_STEPHANIE	
11-3-83		ADDR DECODE / COLLISION REG	
RDH 4/6/84		SHEET // OF 15 REV	

P1GR IS ALSO P1GRR

16 MAY 84 19:09 / USER:BOB/TIA-MARIA/STEPHANIE 11.DRAW

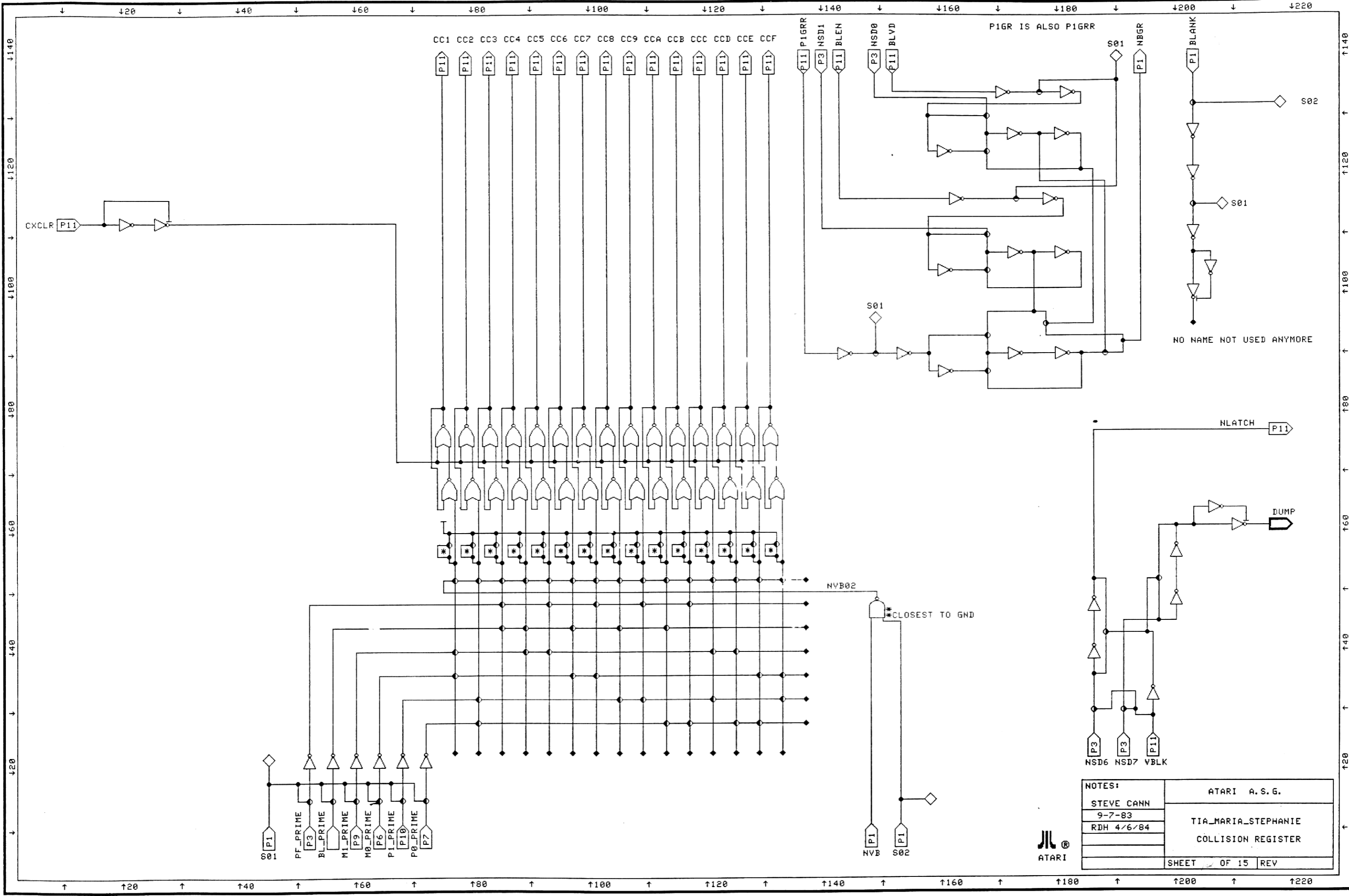

NOTES:		ATARI A. S. G.	
STEVE CANN		TIA_MARIA_STEPHANIE	
9-7-83		COLLISION REGISTER	
RDH 4/6/84		SHEET OF 15 REV	

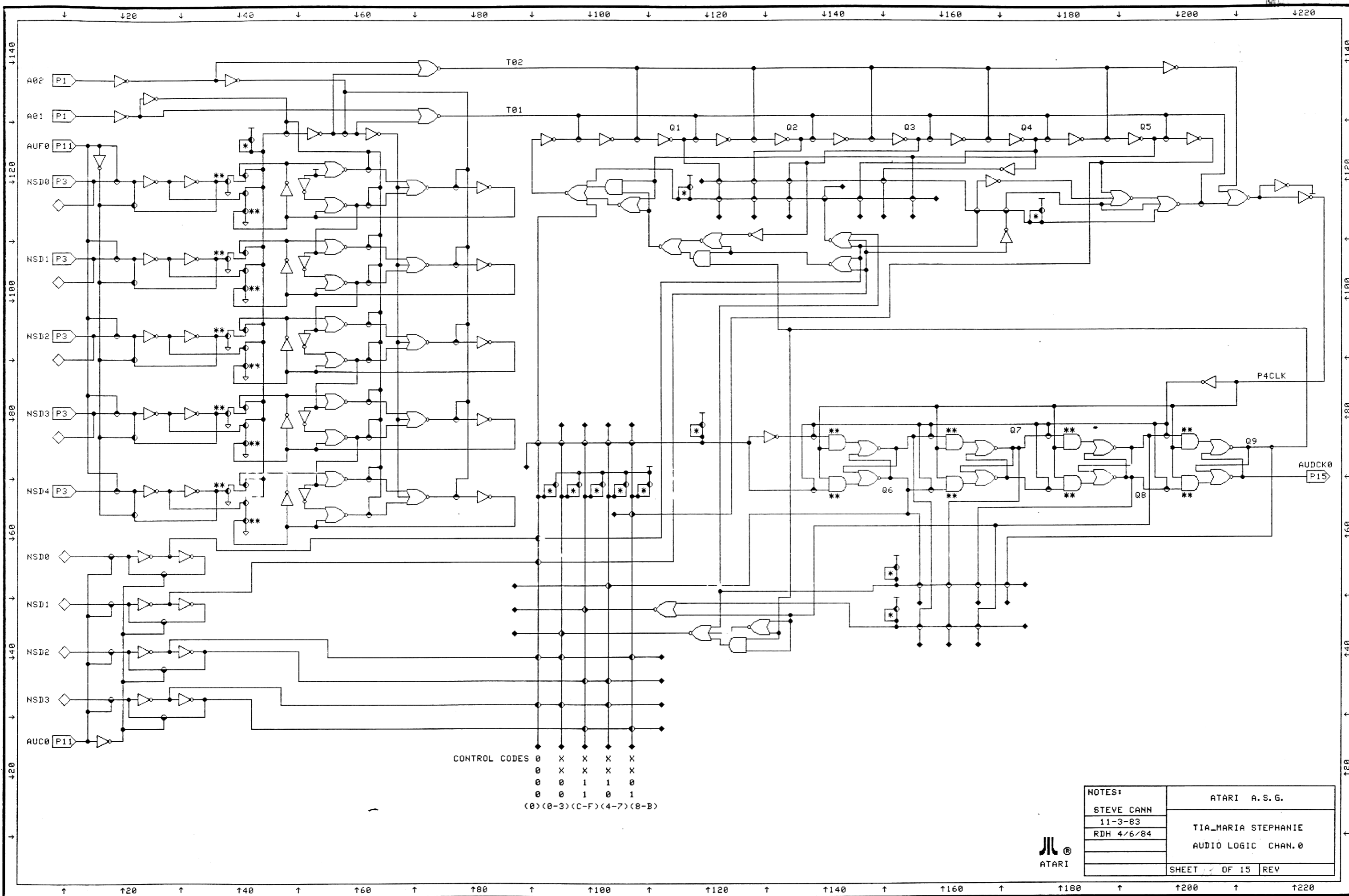

CONTROL CODES 0 X X X X  
 0 X X X X  
 0 0 1 1 0  
 0 0 1 0 1  
 (0)(0-3)(C-F)(4-7)(8-B)



NOTES:	ATARI A. S. G.
STEVE CANN	
11-3-83	
RDH 4/6/84	TIA-MARIA STEPHANIE
	AUDIO LOGIC CHAN. 0
	SHEET 13 OF 15 REV

16 MAY 84 19:13 /USER/BOB/TIA-MARIA-STEPHANIE 13.DRAW

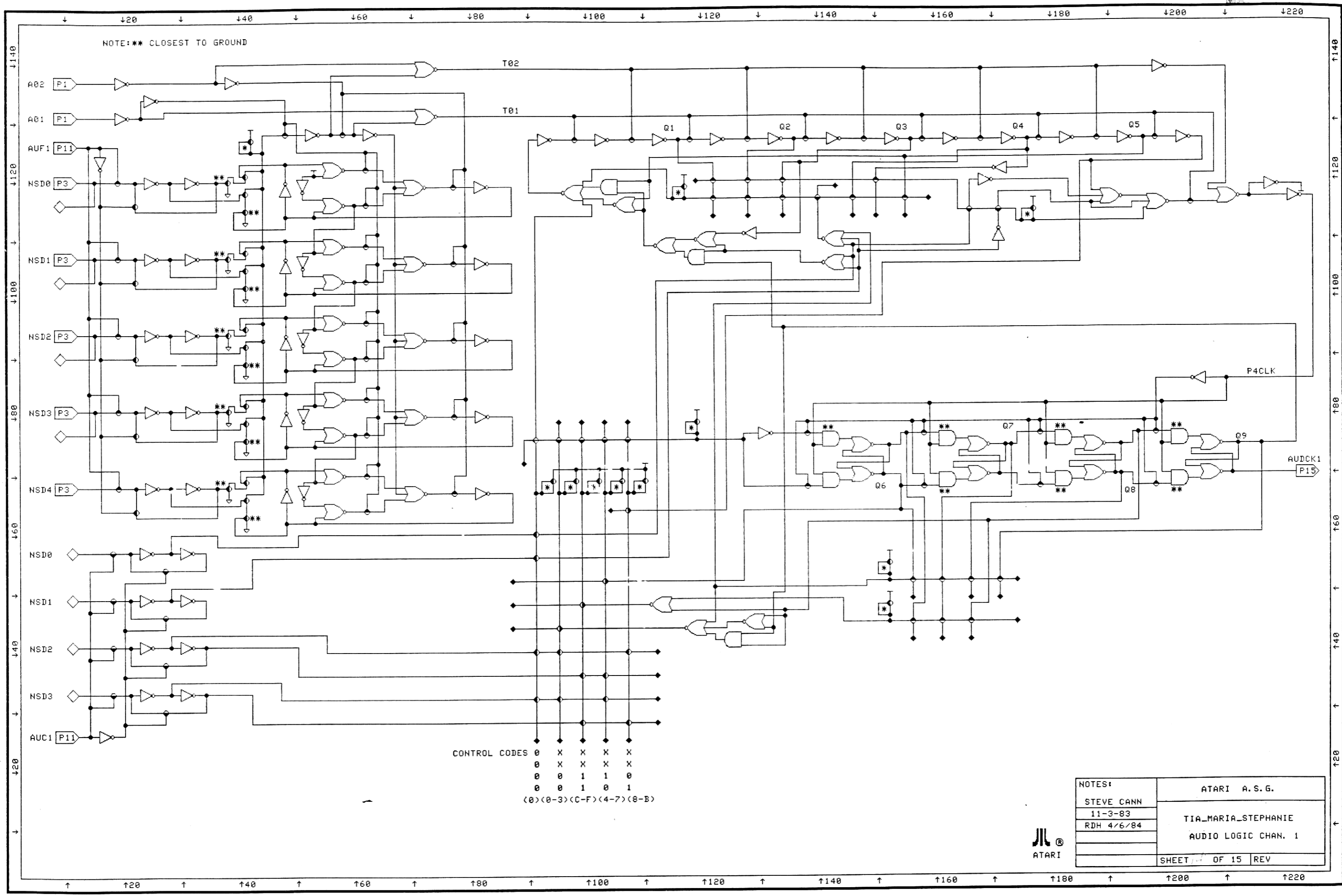

16 MAY 84 19:14 ZUSER780B7TIA-MARIA-STEPHANIE 14. DRAM

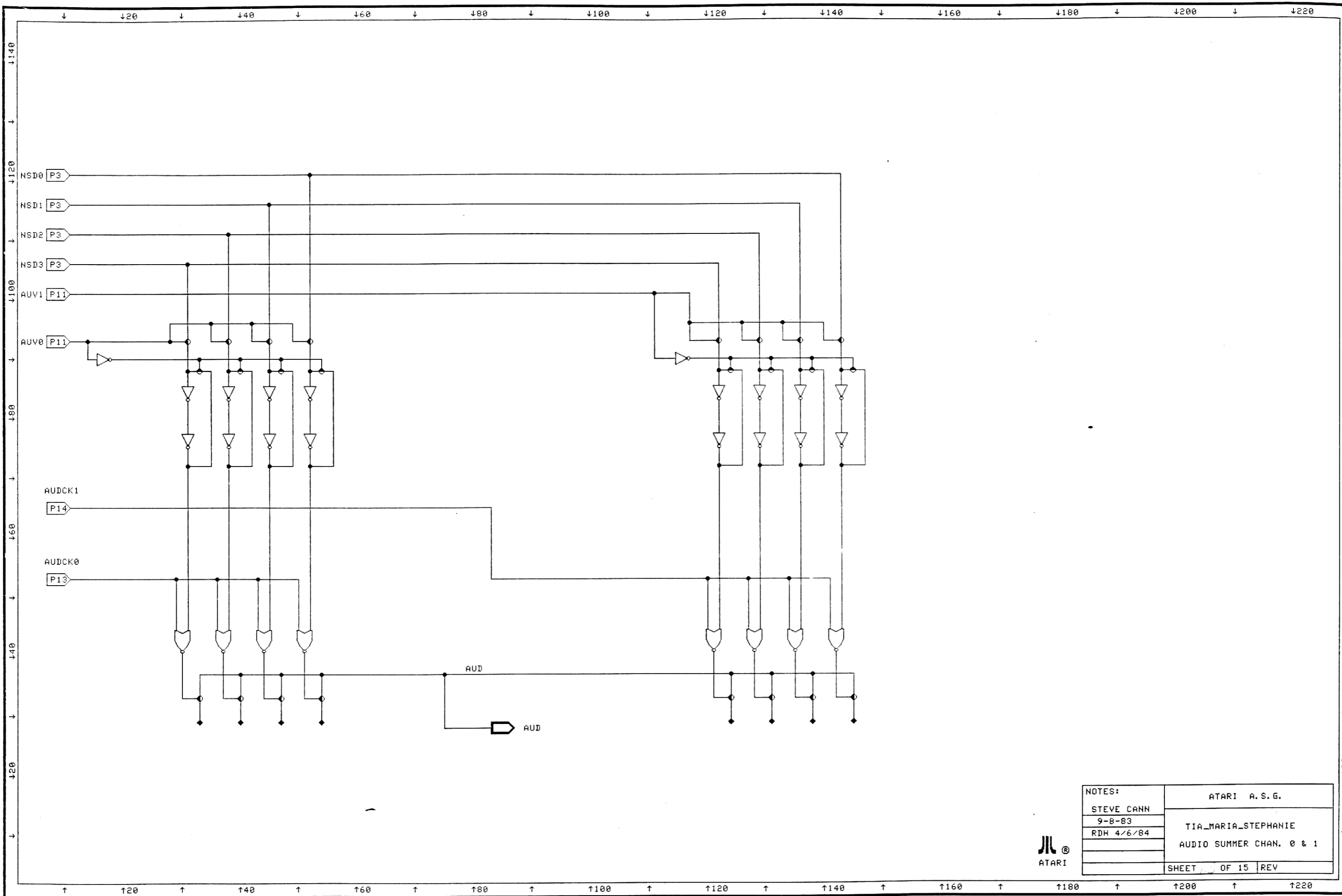

NOTES:	ATARI A. S. G.
STEVE CANN	TIA_MARIA_STEPHANIE
9-8-83	AUDIO SUMMER CHAN. 0 & 1
RDH 4/6/84	
	SHEET 15 OF 15 REV



16 MAY 84 19116 ZUSERZBOB/TIA-MARIA-STEPHANIE 15. DRKH

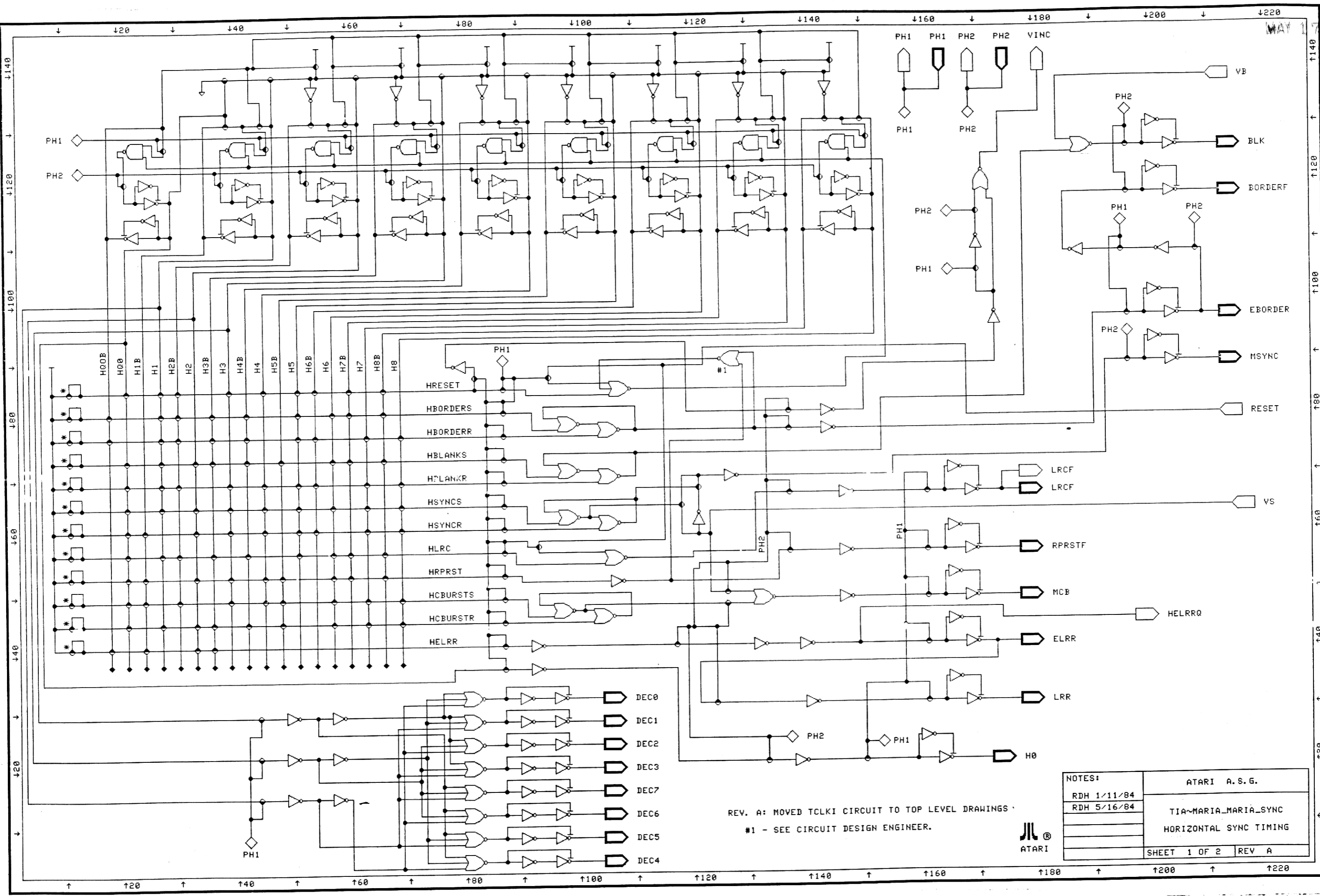

MAY 17 1984

REV. A: MOVED TCLKI CIRCUIT TO TOP LEVEL DRAWINGS  
 #1 - SEE CIRCUIT DESIGN ENGINEER.



NOTES:	ATARI A.S.G.
RDH 1/11/84	TIA-MARIA-MARIA_SYNC
RDH 5/16/84	HORIZONTAL SYNC TIMING
	SHEET 1 OF 2 REV A

16 MAY 84 18:45 USER:BOB/TIA-MARIA/MARIA\_SYNC I. DRAN



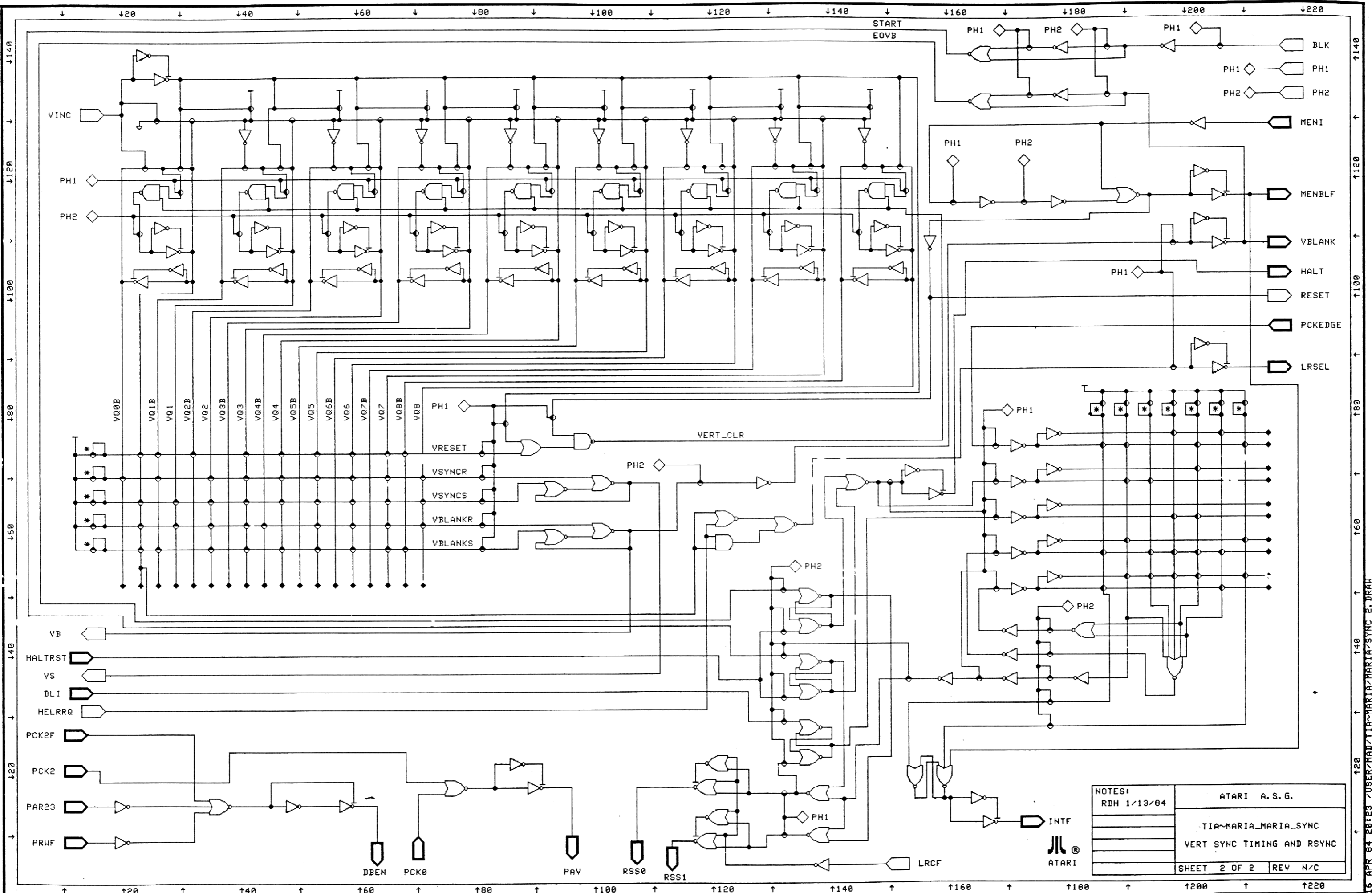

NOTES: RDH 1/13/84	ATARI A. S. G.
	TIA~MARIA_MARIA_SYNC
	VERT SYNC TIMING AND RSYNC
	SHEET 2 OF 2 REV N/C



16 APR 84 20:23 USER/MAD/TIA-MARIA/MARIA\_SYNC 2.DRAW

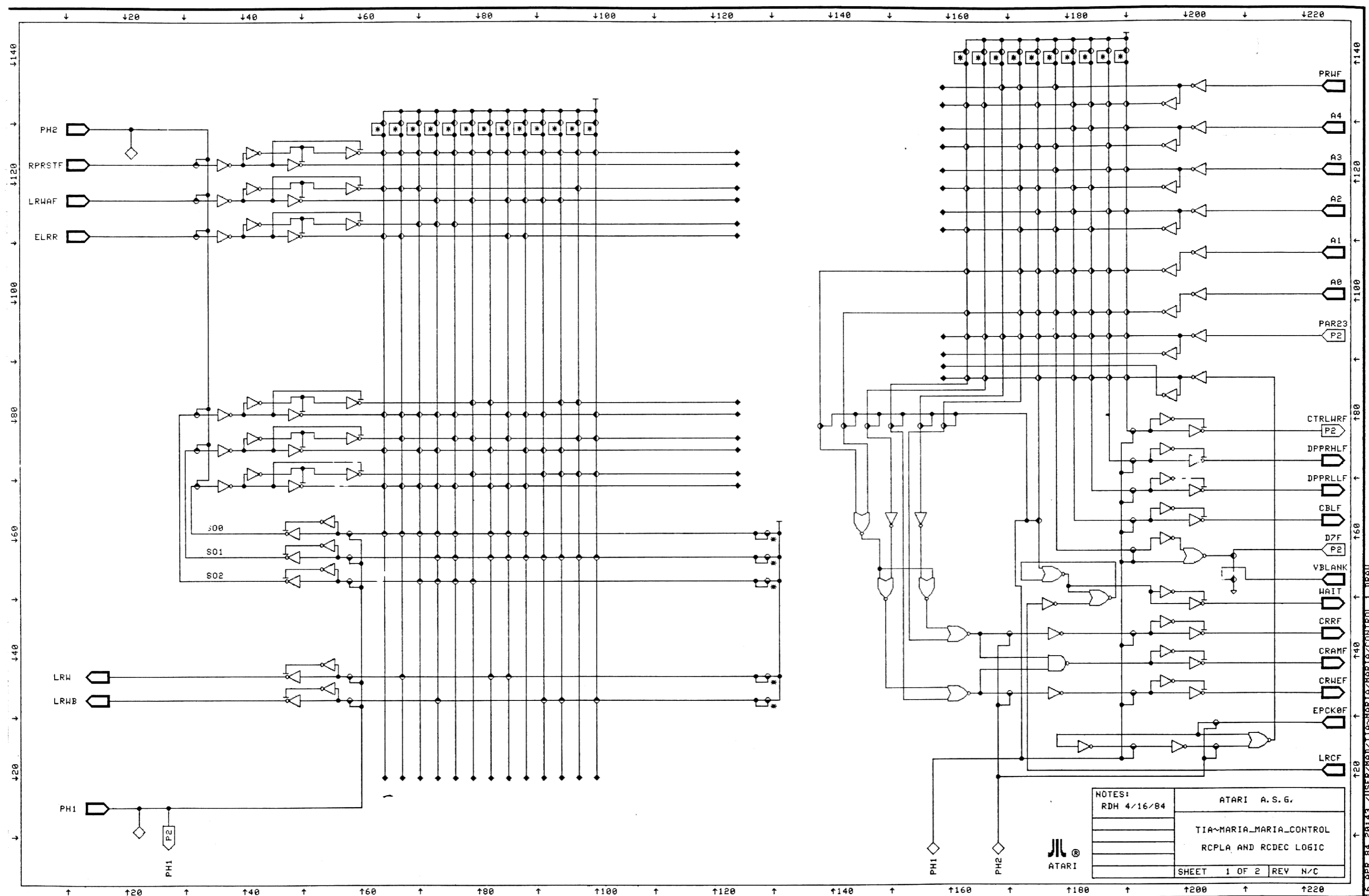

NOTES: RDH 4/16/84	ATARI A.S.G.
	TIA-MARIA_MARIA_CONTROL
	RCPLA AND RCDEC LOGIC
	SHEET 1 OF 2   REV N/C



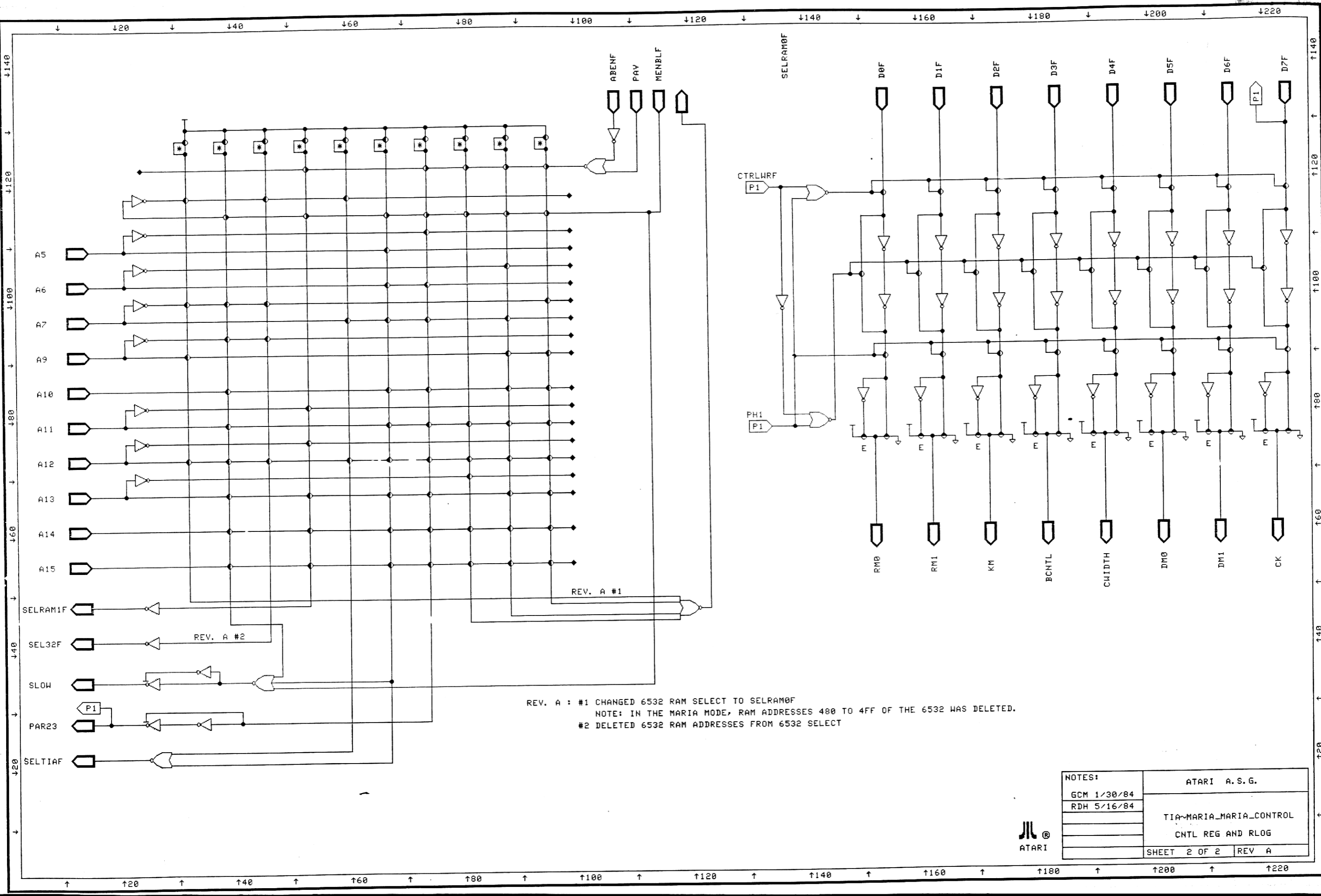

REV. A : #1 CHANGED 6532 RAM SELECT TO SELRAM0F  
 NOTE: IN THE MARIA MODE, RAM ADDRESSES 480 TO 4FF OF THE 6532 WAS DELETED.  
 #2 DELETED 6532 RAM ADDRESSES FROM 6532 SELECT

NOTES:	ATARI A. S. G.
GCM 1/30/84	TIA-MARIA_MARIA_CONTROL
RDH 5/16/84	
	CNTL REG AND RLOG
	SHEET 2 OF 2 REV A



16 MAY 84 18:34 USER:BOB/TIA-MARIA/MARIA\_CONTROL 2. JRAH

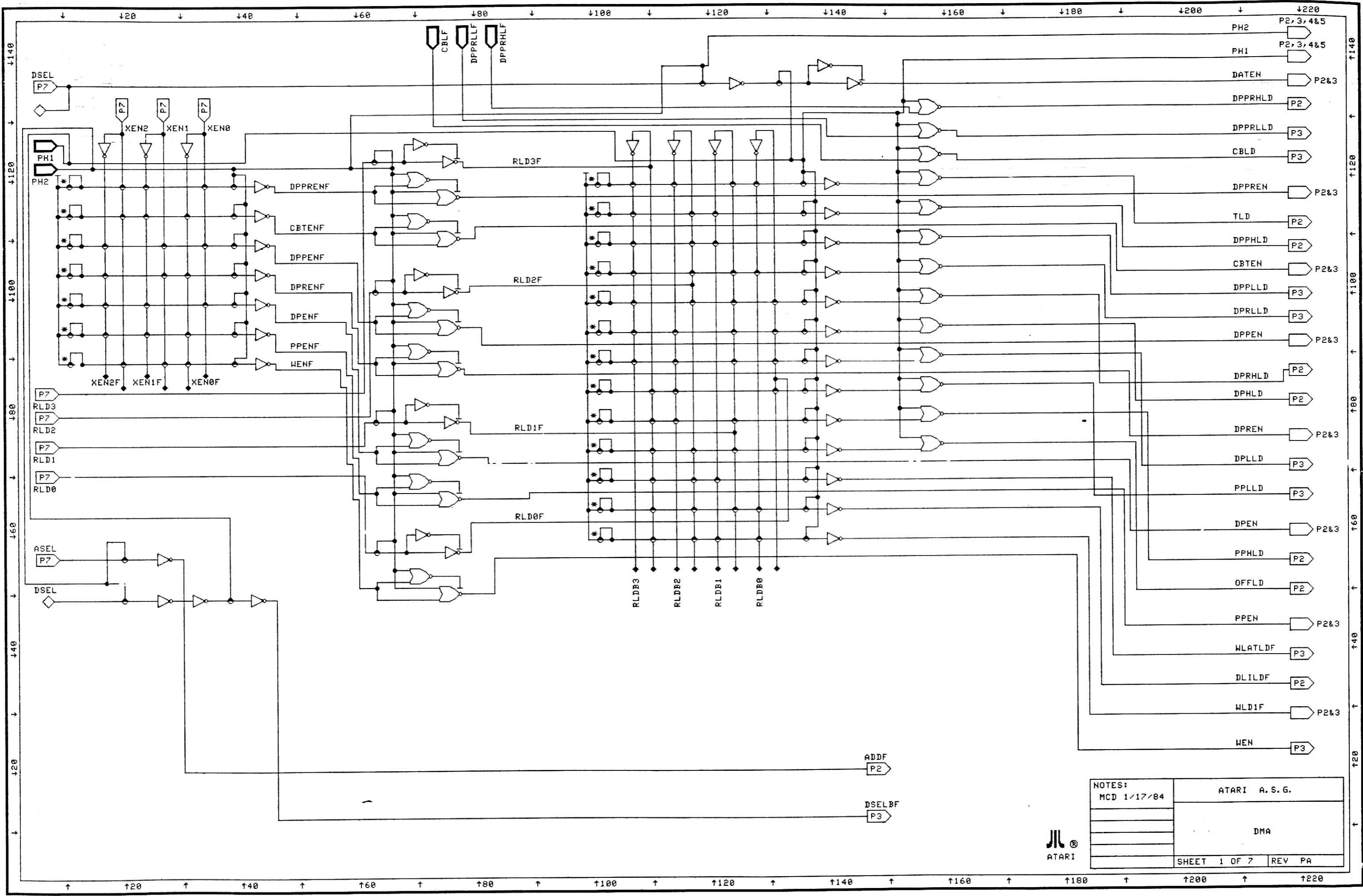

NOTES: MCD 1/17/84	ATARI A. S. G.	
	DMA	
	SHEET 1 OF 7	REV PA



13 APR 84 12:57 / USER: MAD71A\_MARIA/MARIA/DMA 1. DRAM

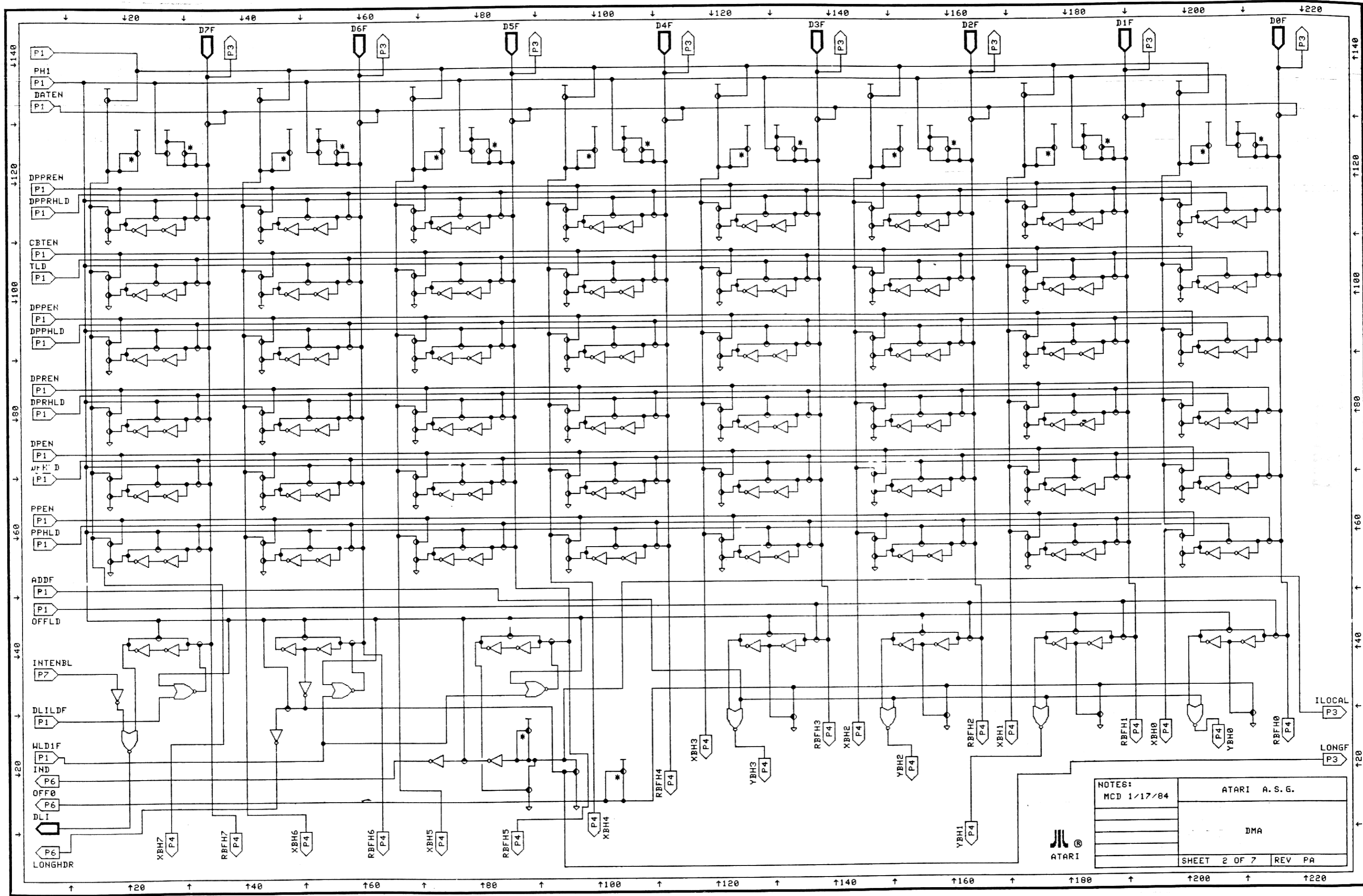

NOTES:  
MCD 1/17/84

ATARI A. S. G.

DMA



SHEET 2 OF 7 REV PA

13 APR 84 13:00 70SER/7AD7TIA-MARIA/MARIA/DMA 2. DRAN

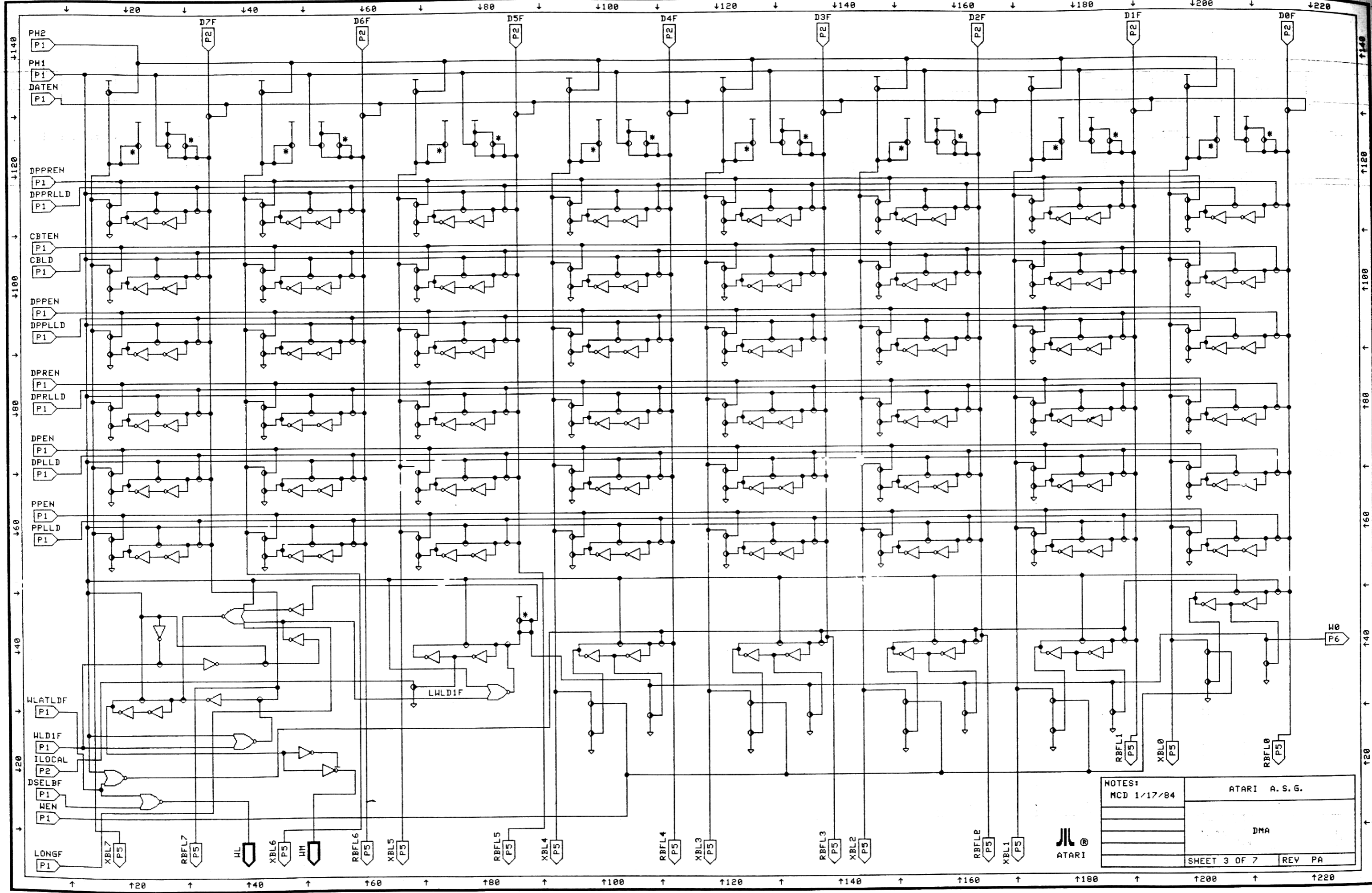

NOTES: MCD 1/17/84	ATARI A. S. G.
	DMA
SHEET 3 OF 7	
REV PA	



13 APR 84 13102 USER71802 CA MARTIN/ATARI/JR

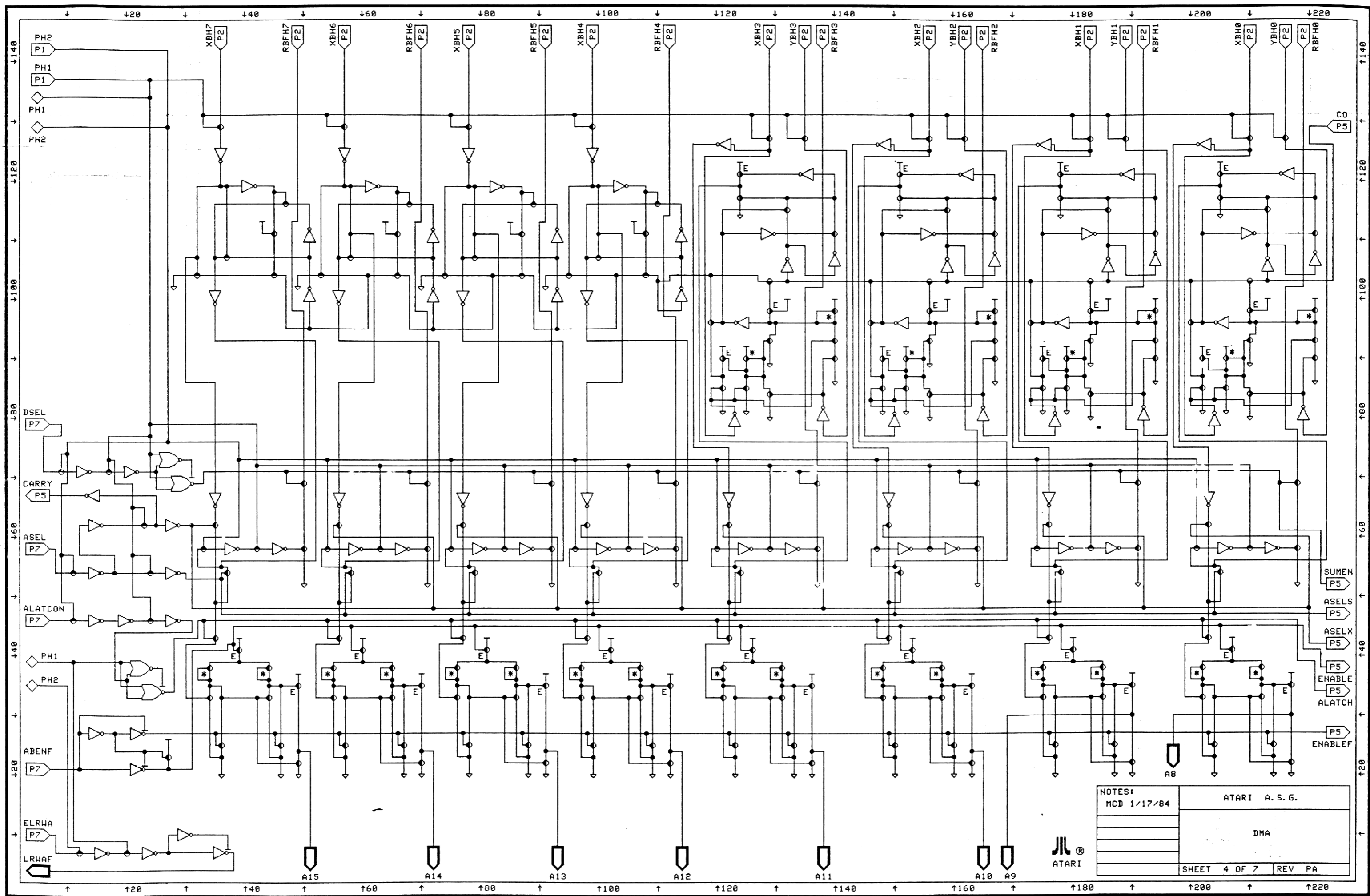

NOTES:  
MCD 1/17/84

ATARI A. S. G.	
DMA	
SHEET 4 OF 7	REV PA



MAR 17 1984

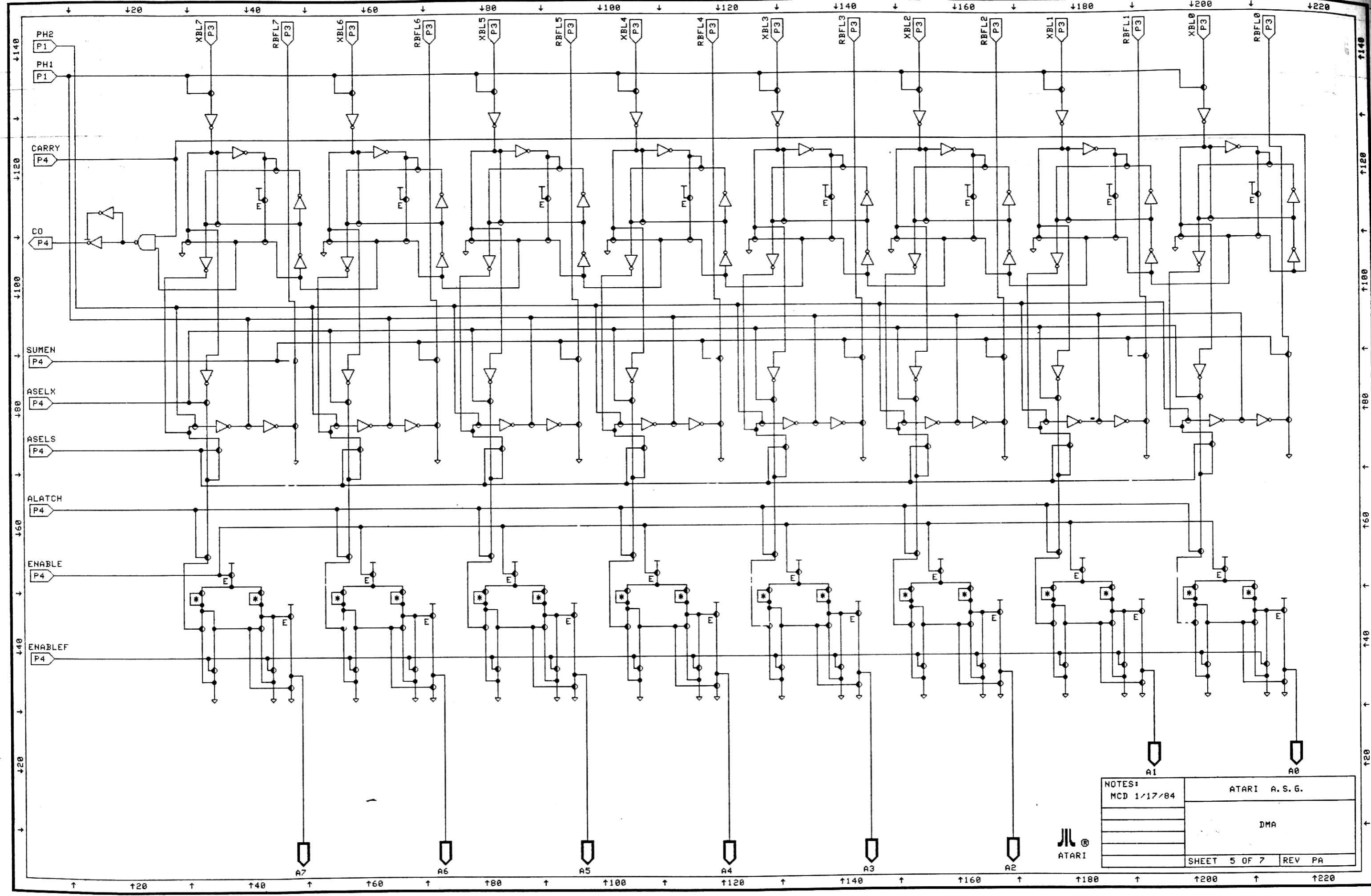

NOTES: MCD 1/17/84	ATARI A. S. G.
	DMA
	SHEET 5 OF 7
	REV PA



13 APR 84 13114 7USER/MAD/TIA\_MARIA/MARIA/DMA S. DEKAM



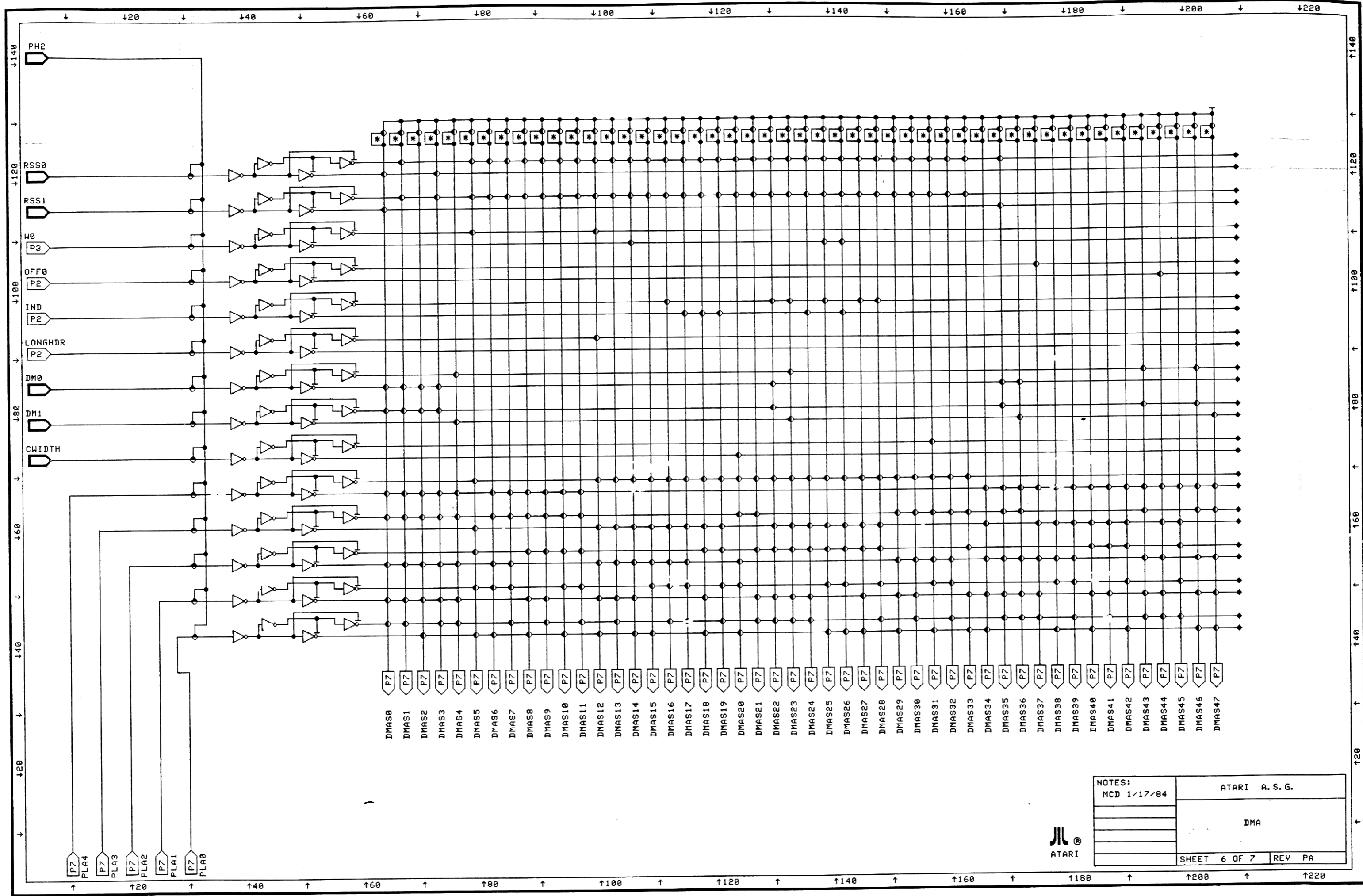

NOTES: MCD 1/17/84	ATARI A. S. G.
	DMA
	SHEET 6 OF 7
	REV PA



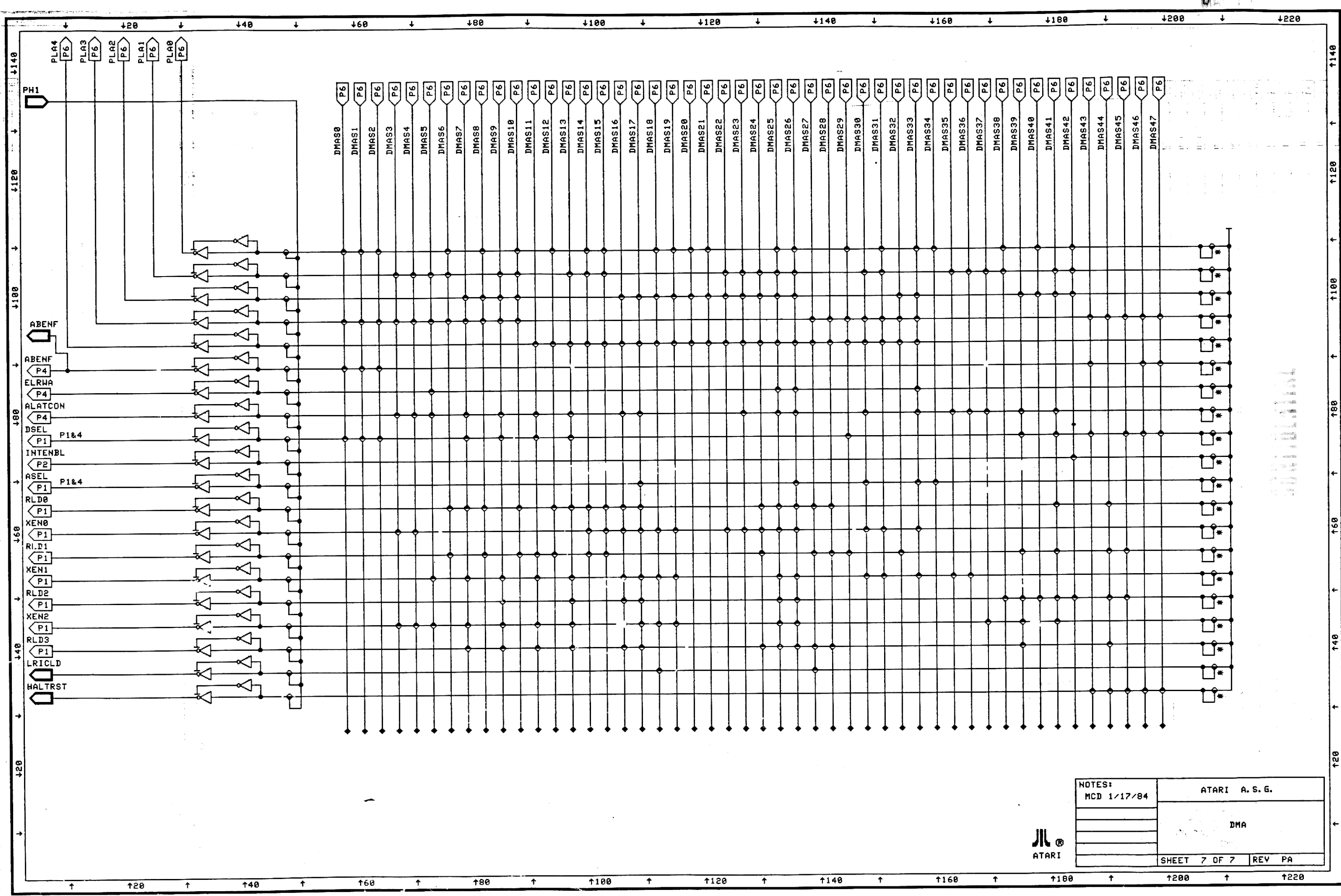

NOTES:	ATARI A. S. G.
MCD 1/17/84	
	DMA
	SHEET 7 OF 7
	REV PA



13 APR 84 13129 7USER/MAD/TIA\_MARIA/MARIA/DMA 7.DRAW

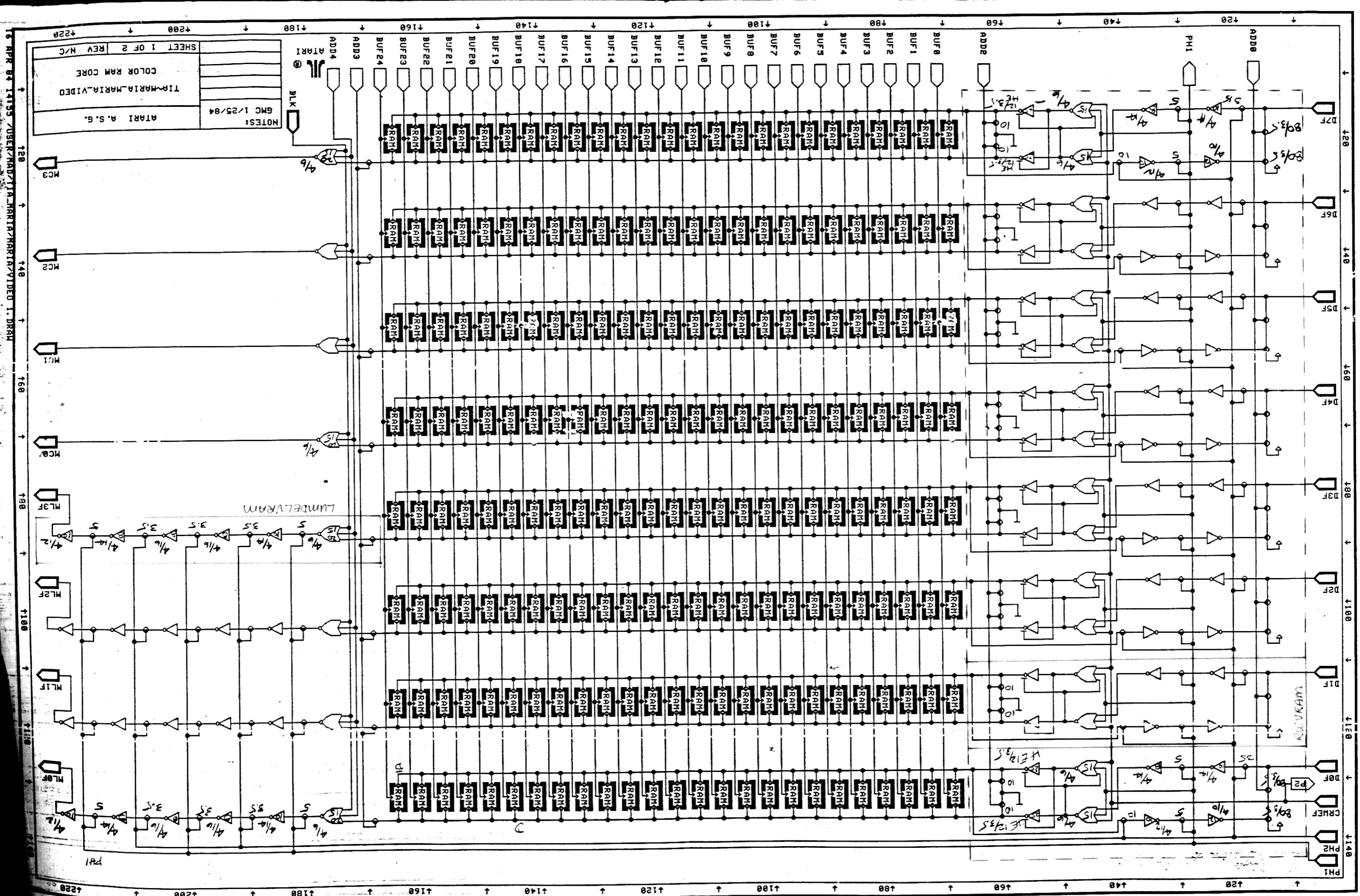

NOTES:  
 GMC 1/25/84  
 TIRMARIA-MARIA-VIDEO  
 COLOR RAM CORE  
 REV N/C  
 SHEET 1 OF 2

ATARI A.S.G.

1220 1200 1180 1160 1140 1120 1100 1080 1060 1040 1020 1000 980 960 940 920 900 880 860 840 820 800 780 760 740 720 700 680 660 640 620 600 580 560 540 520 500 480 460 440 420 400 380 360 340 320 300 280 260 240 220 200 180 160 140 120 100 80 60 40 20

1220 1200 1180 1160 1140 1120 1100 1080 1060 1040 1020 1000 980 960 940 920 900 880 860 840 820 800 780 760 740 720 700 680 660 640 620 600 580 560 540 520 500 480 460 440 420 400 380 360 340 320 300 280 260 240 220 200 180 160 140 120 100 80 60 40 20

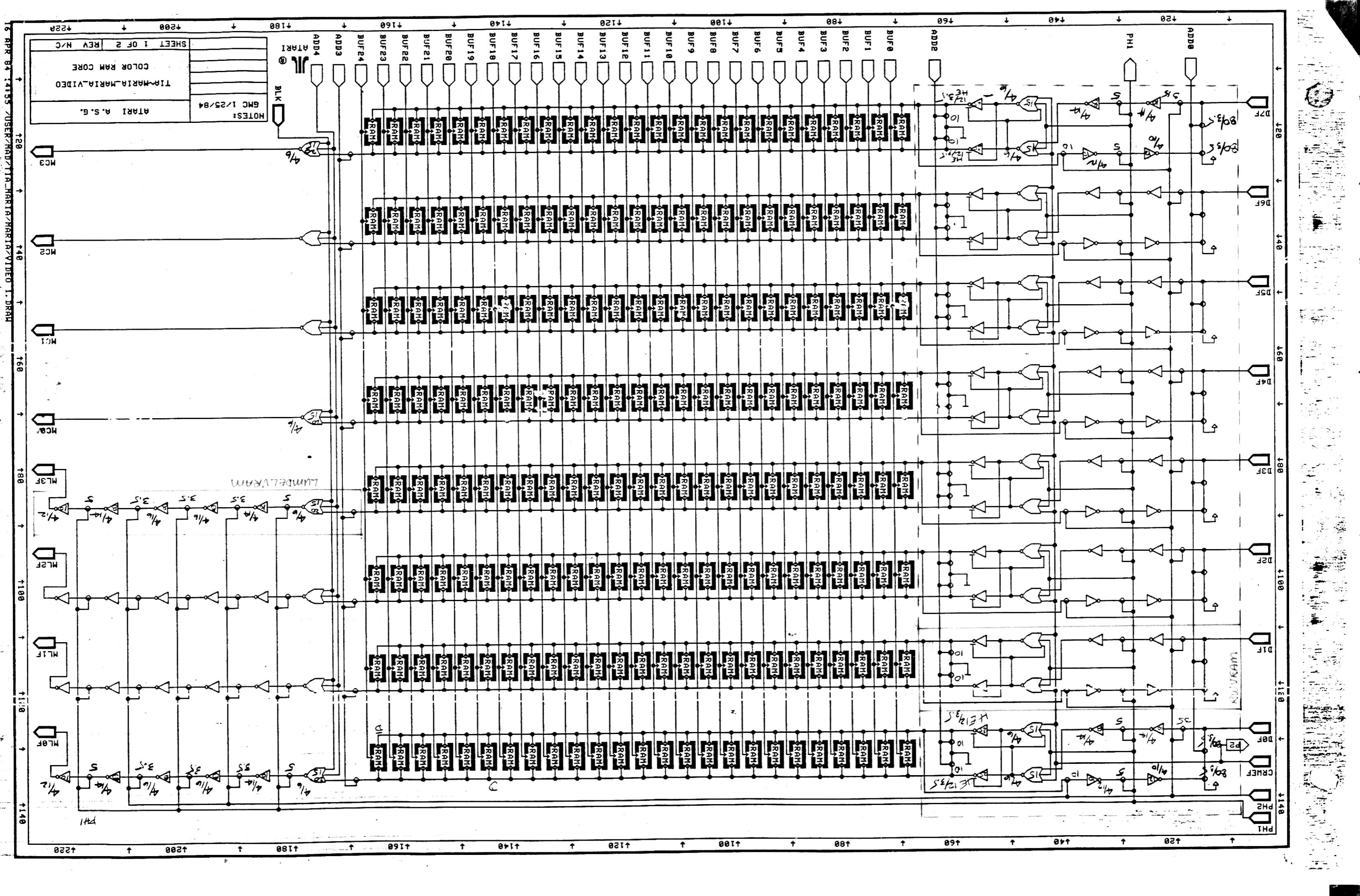

NOTES:  
GMC 1/25/84  
TIRMARIA-MARIA-VIDEO  
ATARI A.S.G.  
SHEET 1 OF 2 REV N/C  
COLOR RAM CORE

1220  
1200  
1180  
1160  
1140  
1120  
1100  
1080  
1060  
1040  
1020  
1220  
1200  
1180  
1160  
1140  
1120  
1100  
1080  
1060  
1040  
1020

120  
140  
160  
180  
100  
1100  
1120  
1140  
1160  
1180  
1200

1220  
1200  
1180  
1160  
1140  
1120  
1100  
1080  
1060  
1040  
1020

120  
140  
160  
180  
100  
1100  
1120  
1140  
1160  
1180  
1200

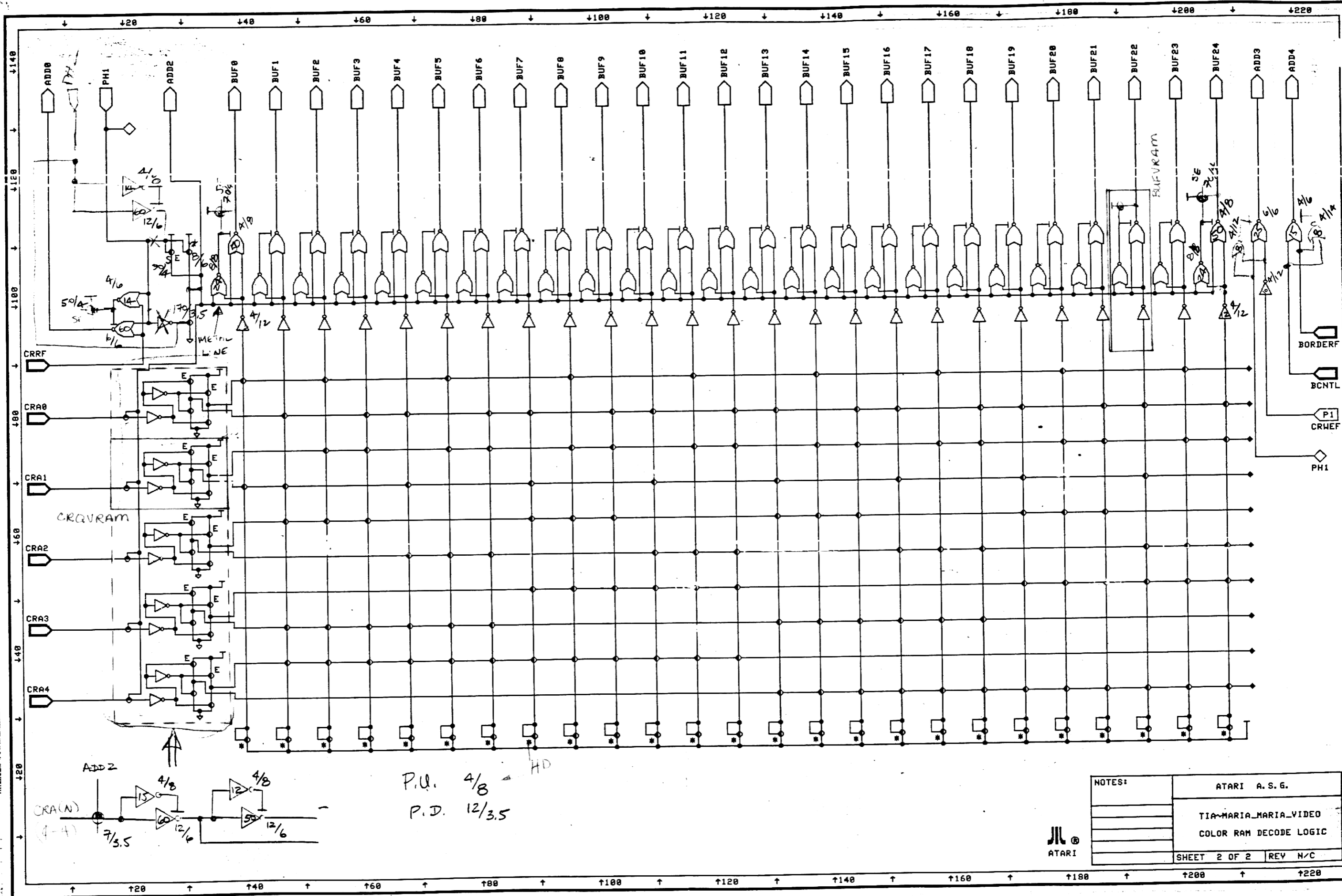

P.U. 4/8 HD  
 P.D. 12/3.5

NOTES:	ATARI A. S. G.
	TIA-MARIA-MARIA-VIDEO
	COLOR RAM DECODE LOGIC
	SHEET 2 OF 2 REV N/C



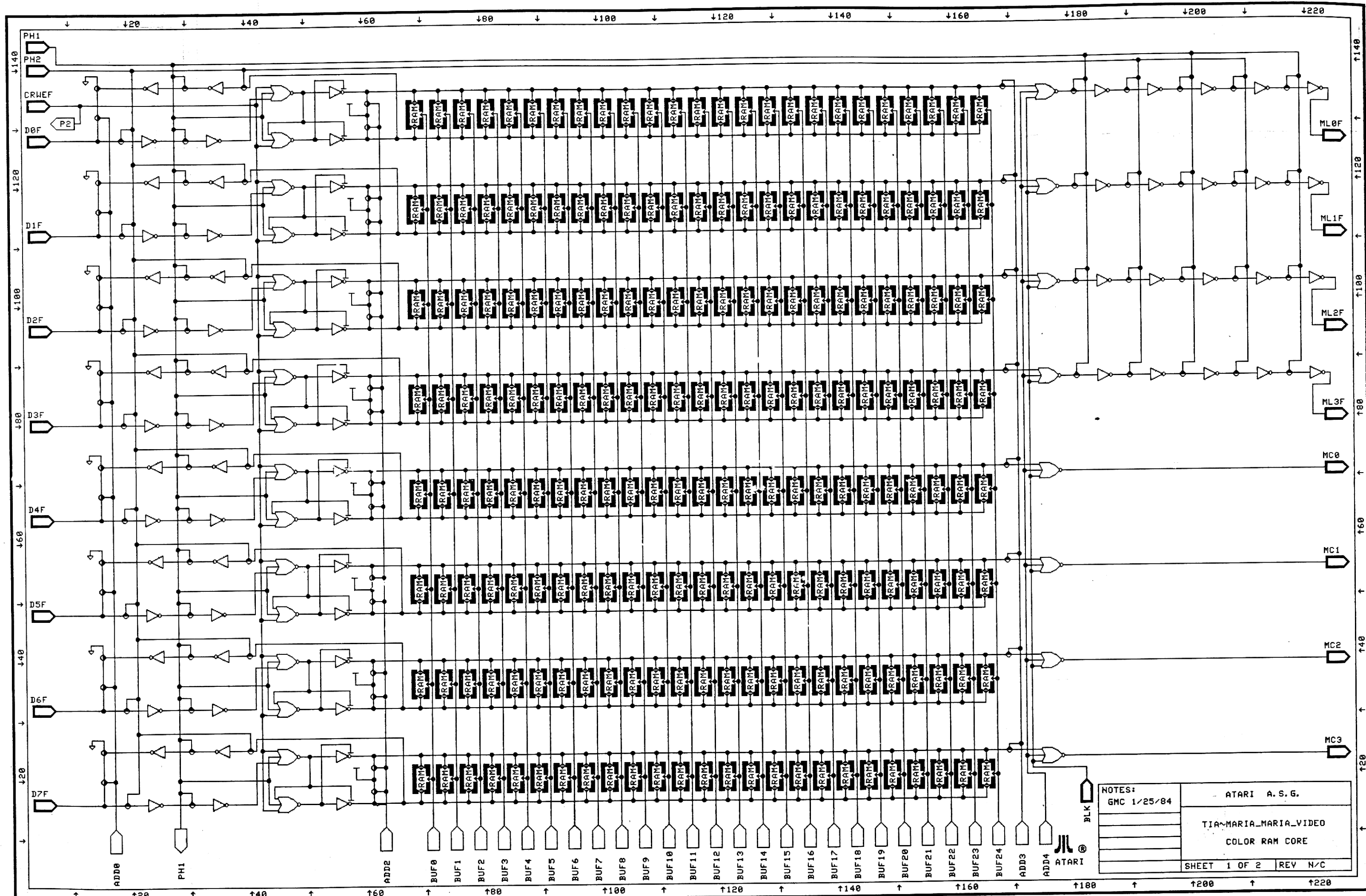

NOTES:  
GMC 1/25/84

ATARI A. S. G.  
TIA-MARIA-MARIA-VIDEO  
COLOR RAM CORE  
SHEET 1 OF 2 REV N/C

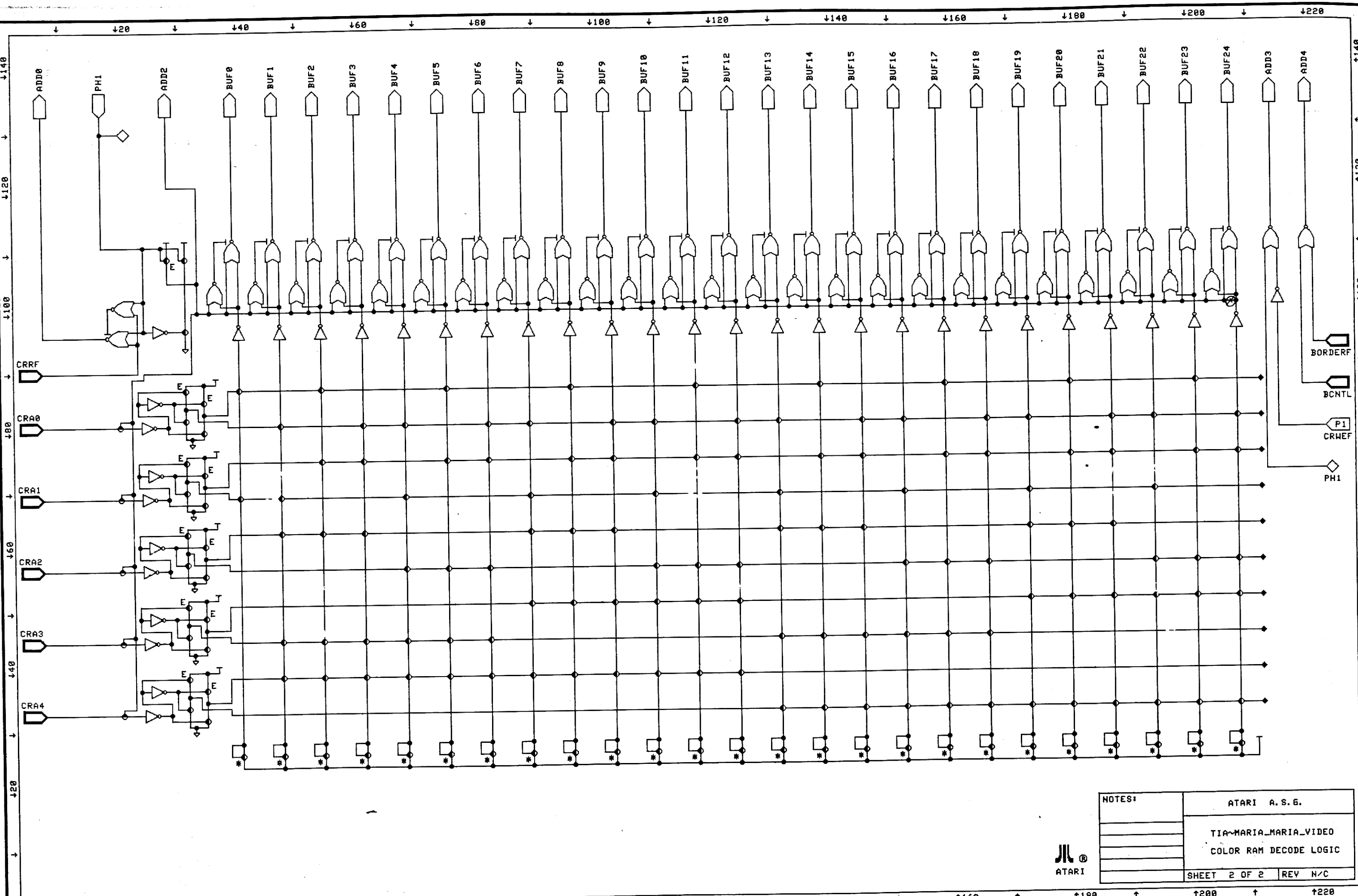

NOTES:	ATARI A. S. G.
	TIA-MARIA-MARIA-VIDEO
	COLOR RAM DECODE LOGIC
	SHEET 2 OF 2 REV N/C

16 APR 84 14:59 USER:RAD/TIA-MARIA-MARIA-VIDEO E. DRAB

CONFIDENTIAL

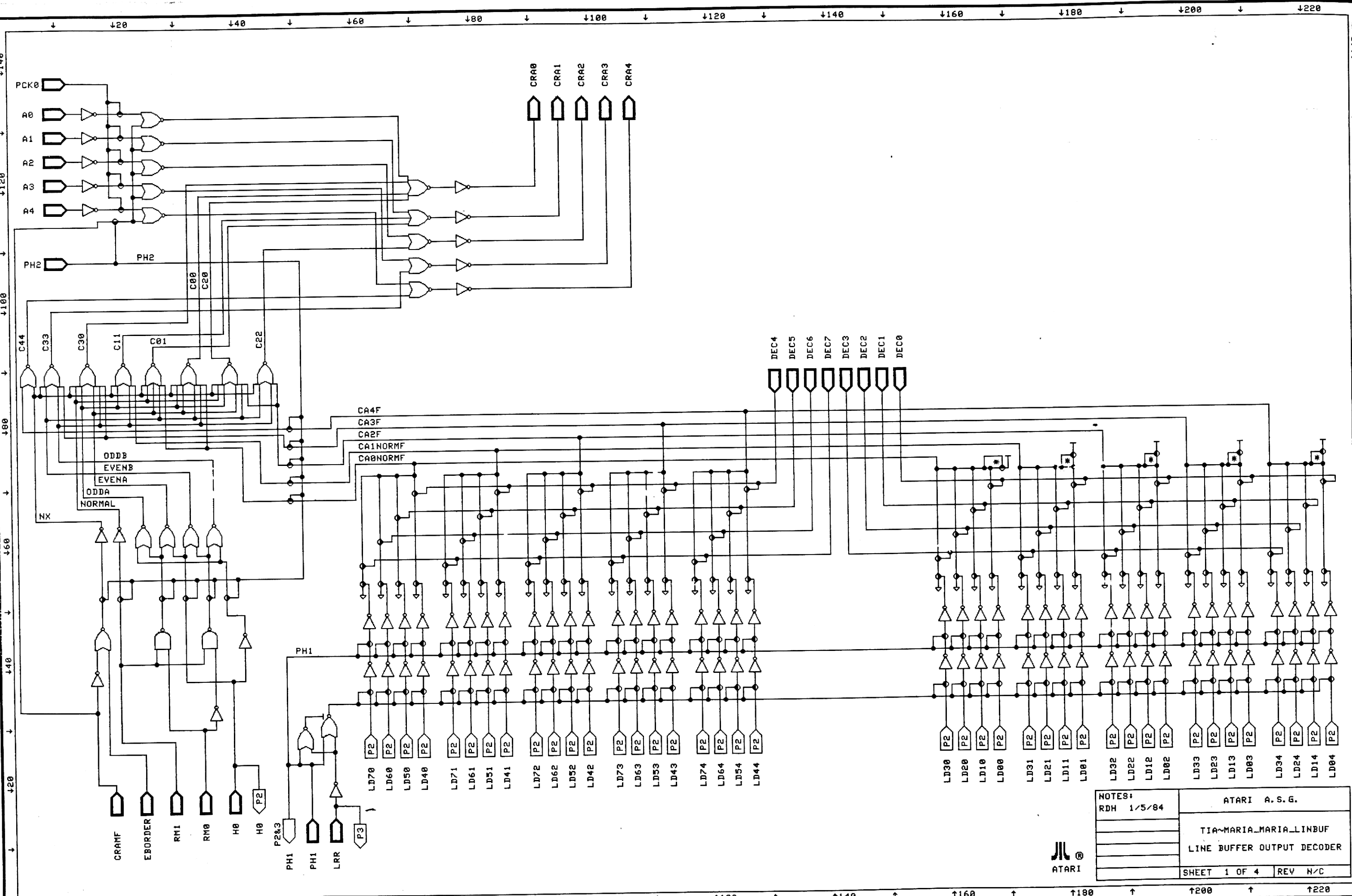

NOTES:  
RDH 1/5/84



ATARI A. S. G.  
TIA-MARIA-MARIA\_LINBUF  
LINE BUFFER OUTPUT DECODER  
SHEET 1 OF 4 REV N/C



MAR 17 1984

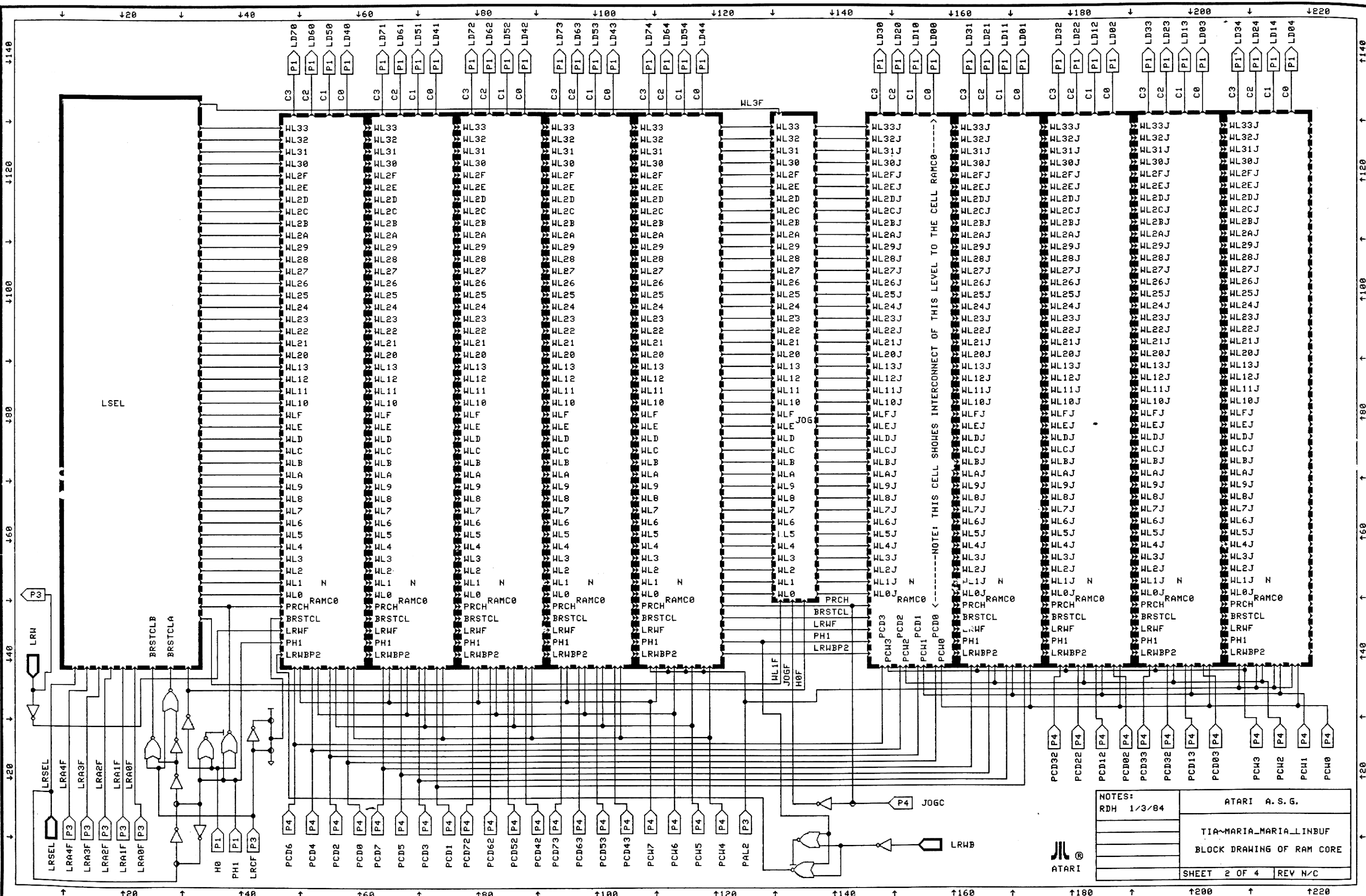

NOTES: RDH 1/3/84	ATARI A. S. G.	
	TIA-MARIA-MARIA-LINBUF BLOCK DRAWING OF RAM CORE	
SHEET 2 OF 4		REV N/C

16 APR 84 16:25 USER:MAD/TIA-MARIA/MARIA-LINBUF 2:JFH

CONFIDENTIAL

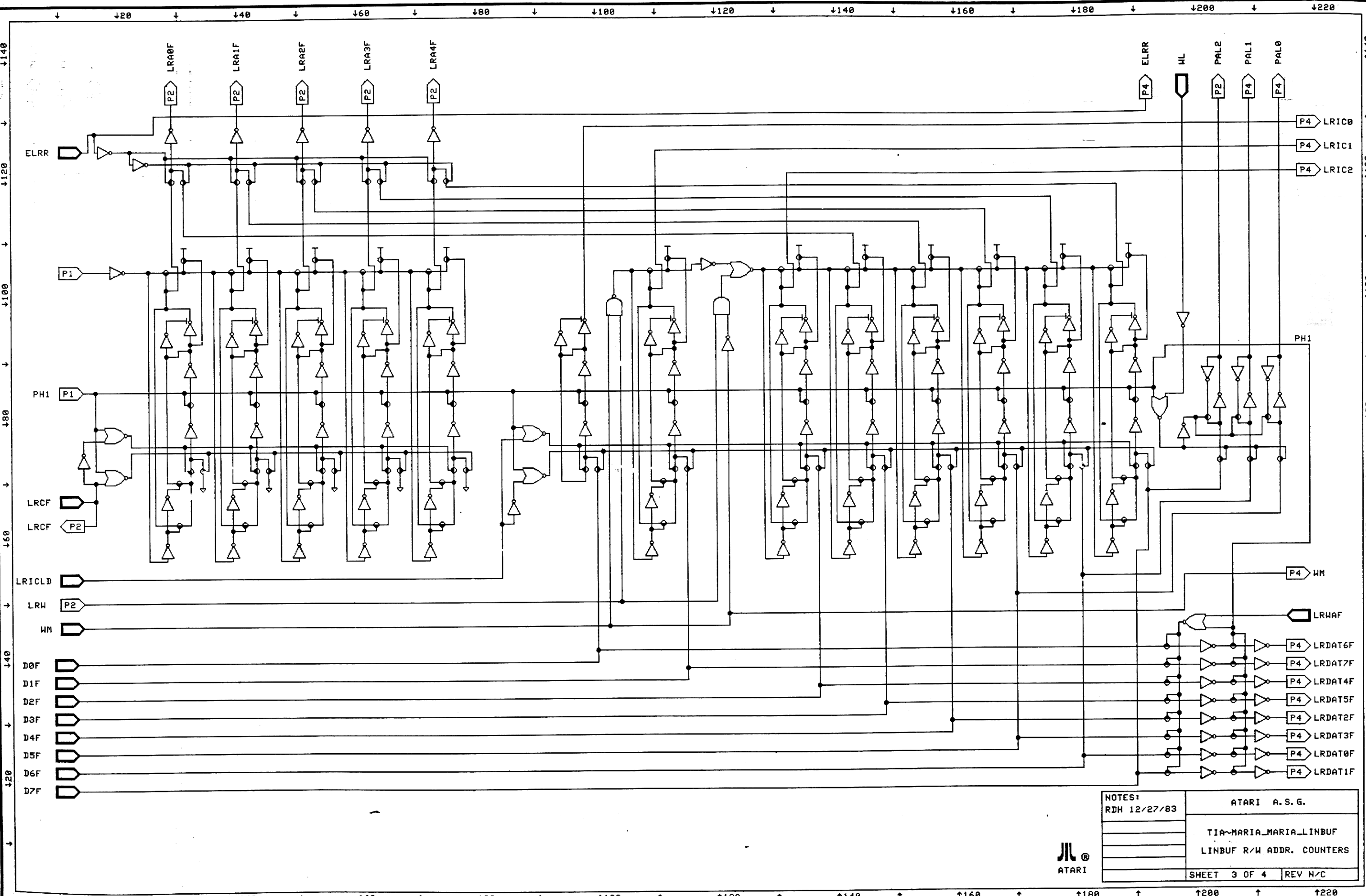

NOTES:  
RDH 12/27/83

ATARI A. S. G.

TIA-MARIA-MARIA-LINBUF  
LINBUF R/W ADDR. COUNTERS

SHEET 3 OF 4 REV N/C



16 APR 84 15119 ZUSER7AD7TIA-MARIA-MARIA-LINBUF 3. DRKH

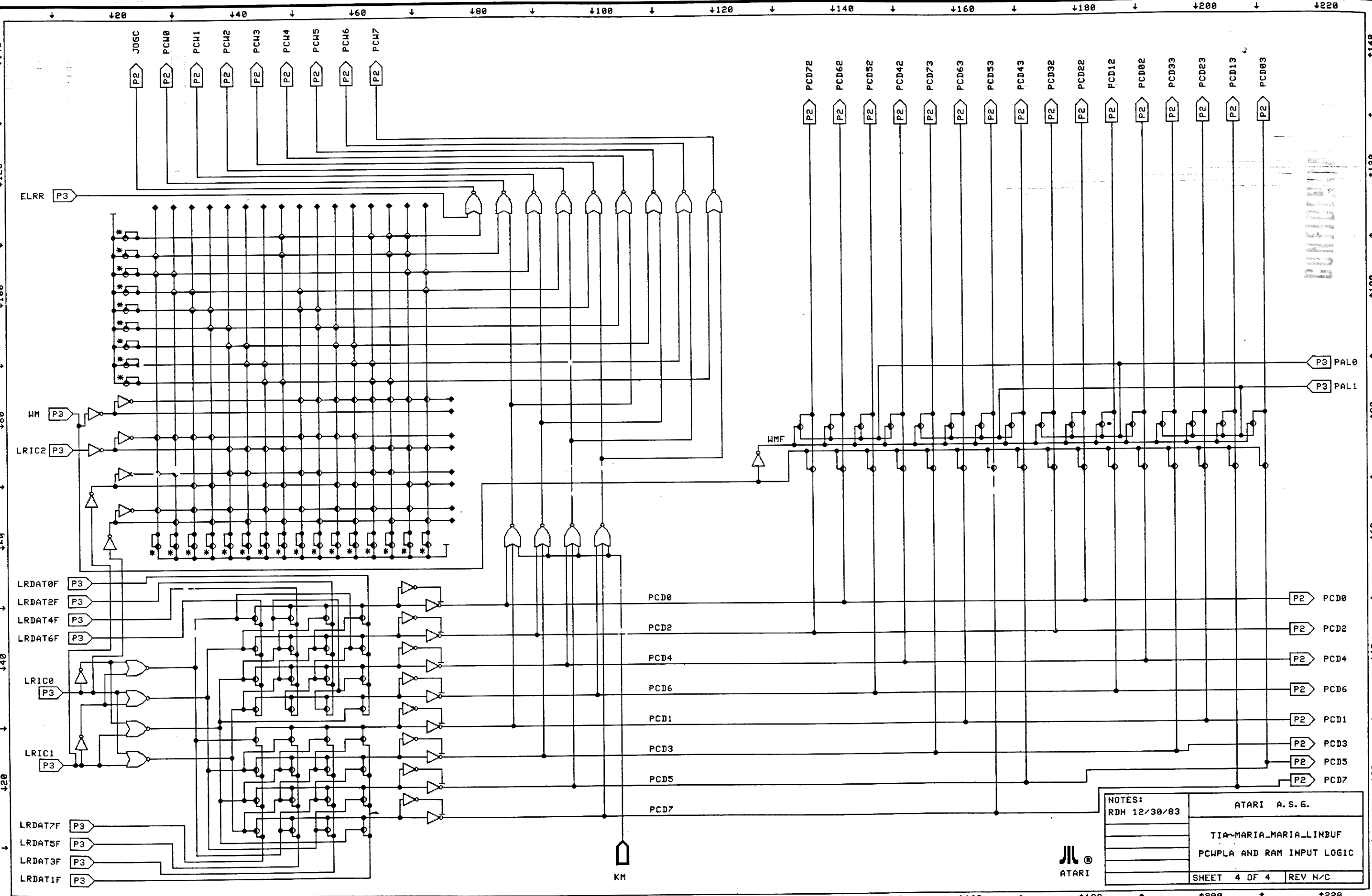

NOTES:  
RDH 12/30/83

ATARI A. S. G.

TIA-MARIA-MARIA-LINBUF  
PCWPLA AND RAM INPUT LOGIC

SHEET 4 OF 4 REV N/C



MAY 17 1984

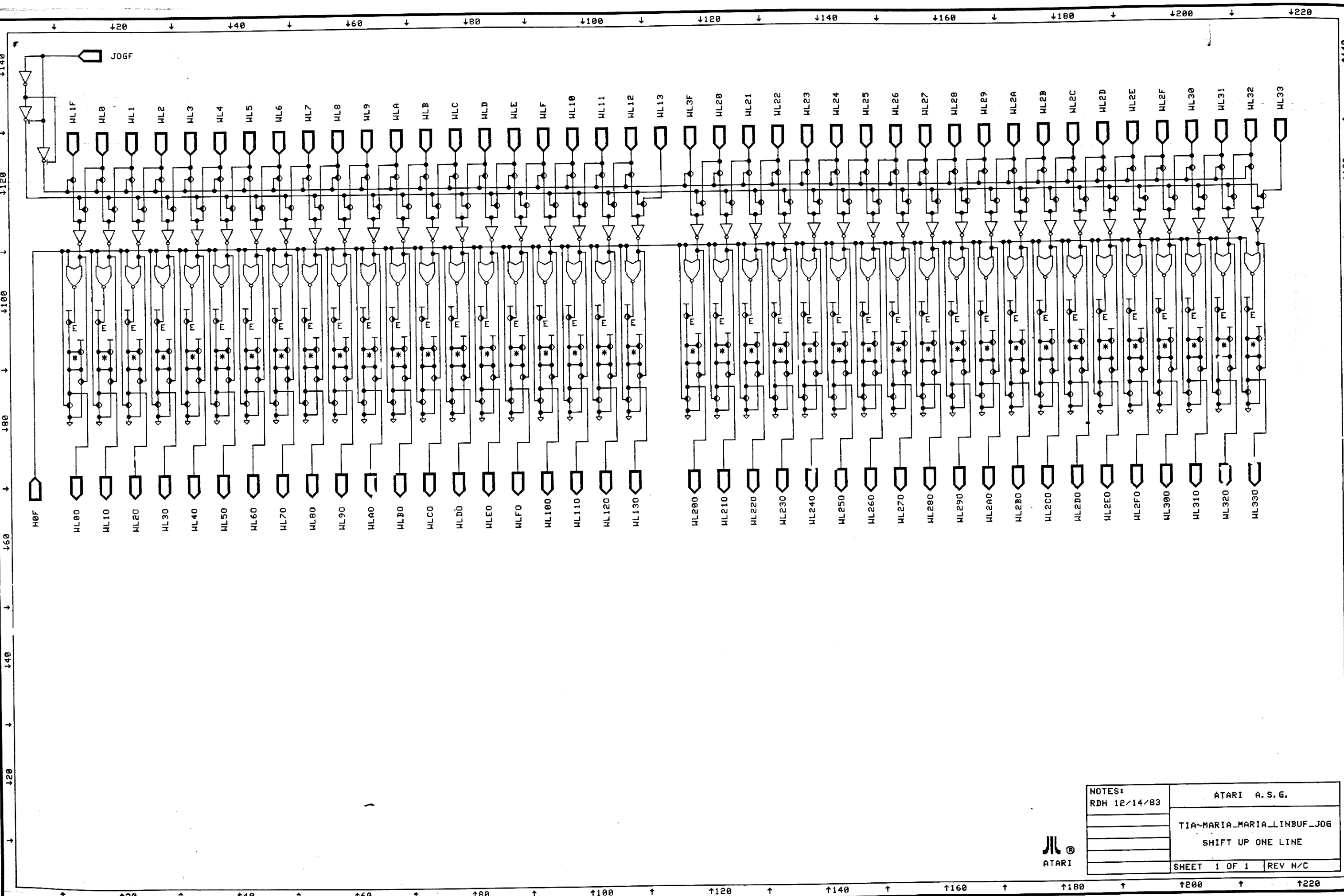

NOTES: RDH 12/14/83	ATARI A. S. G.	
	TIA~MARIA_MARIA_LINBUF_JOG	
	SHIFT UP ONE LINE	
	SHEET 1 OF 1	REV N/C

16 APR 84 16:22 USER/MAD/TIA\_MARIA/MARIA\_LINBUF/JOG I. DRAB

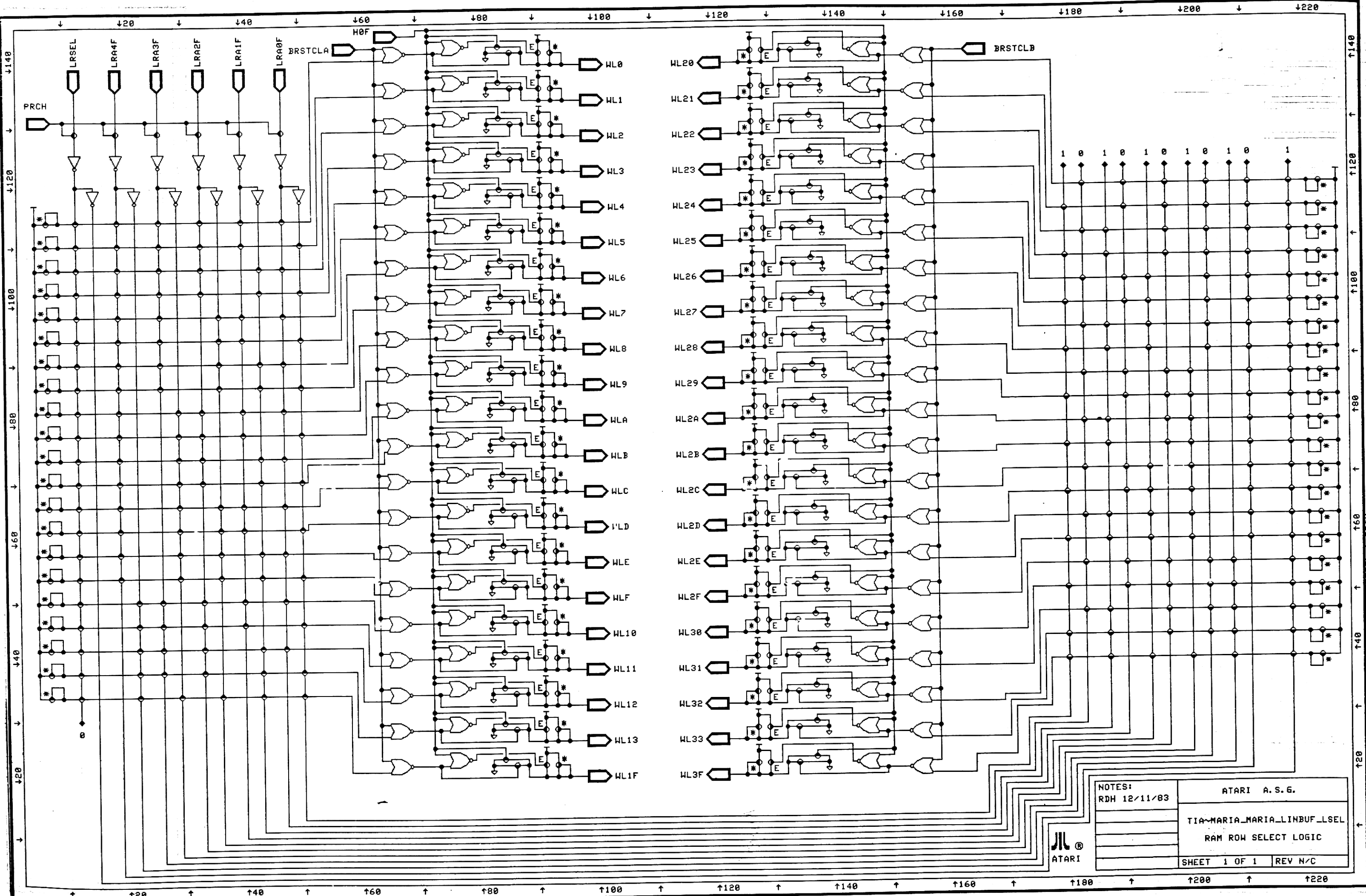

NOTES:  
RDH 12/11/83

ATARI A.S.G.

TIA-MARIA\_MARIA\_LINBUF\_LSEL  
RAM ROW SELECT LOGIC

SHEET 1 OF 1 | REV N/C



16 APR 84 15:33 USER:RAD/TIA-MARIA\_MARIA\_LINBUF\_LSEL L. DRAN

CONFIDENTIAL

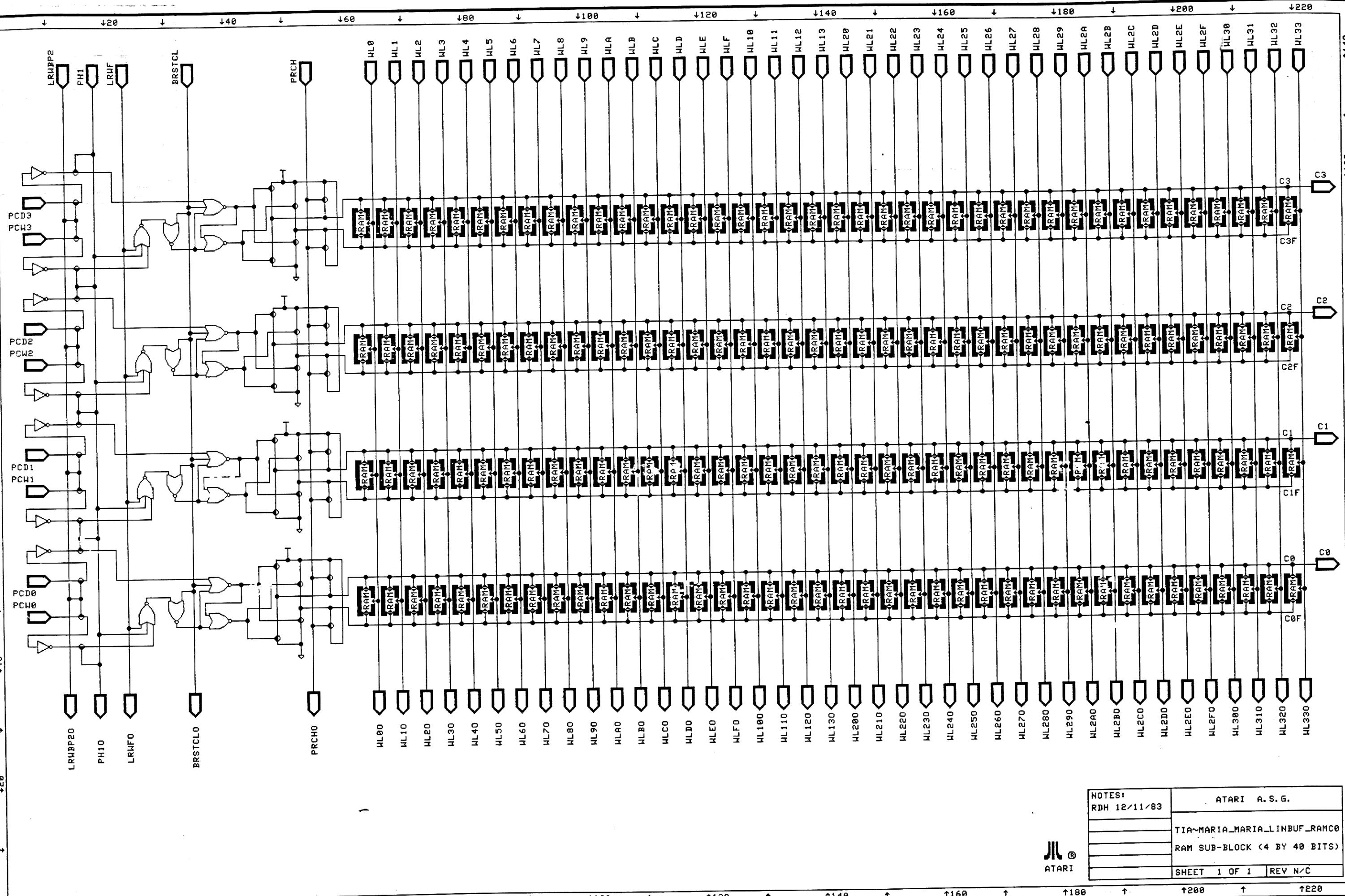

NOTES:	ATARI A. S. G.
RDH 12/11/83	TIA-MARIA_MARIA_LINBUF_RAMC0
	RAM SUB-BLOCK (4 BY 40 BITS)
	SHEET 1 OF 1 REV N/C



MAY 17 1984

CONFIDENTIAL

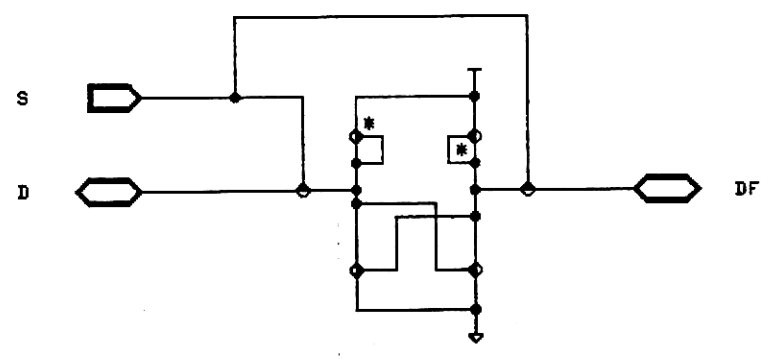

NOTES: RDH 4/16/84	ATARI A.S.G.
	TIA~MARIA_MARIA_LINBUF_RAM
	RAM CELL
	(USED IN COLOR AND LINBUF)
	SHEET 1 OF 1 REV N/C



16 APR 84 17:04 USER:RDH/TIA~MARIA\_MARIA\_LINBUF\_RAM 1. DRAM

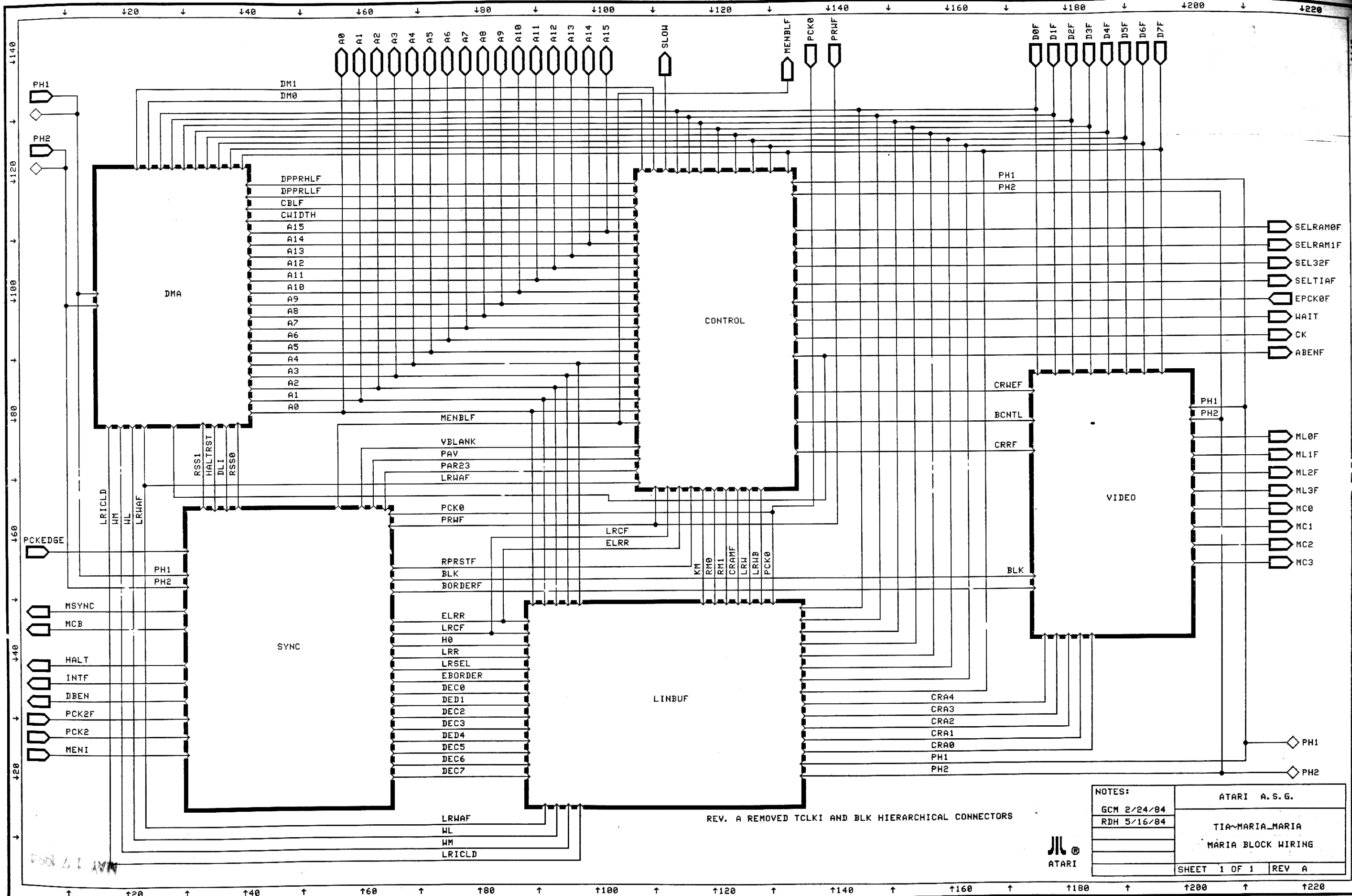

NOTES: GCM 2/24/84 RDH 5/16/84	ATARI A.S.G.	
	TIA~MARIA_MARIA	
	MARIA BLOCK WIRING	
	SHEET 1 OF 1	REV A



16 MAY 84 18142 ZUSER/BOB/TIA-MARIA/MARIA I. DRAM

MAY 17 1984



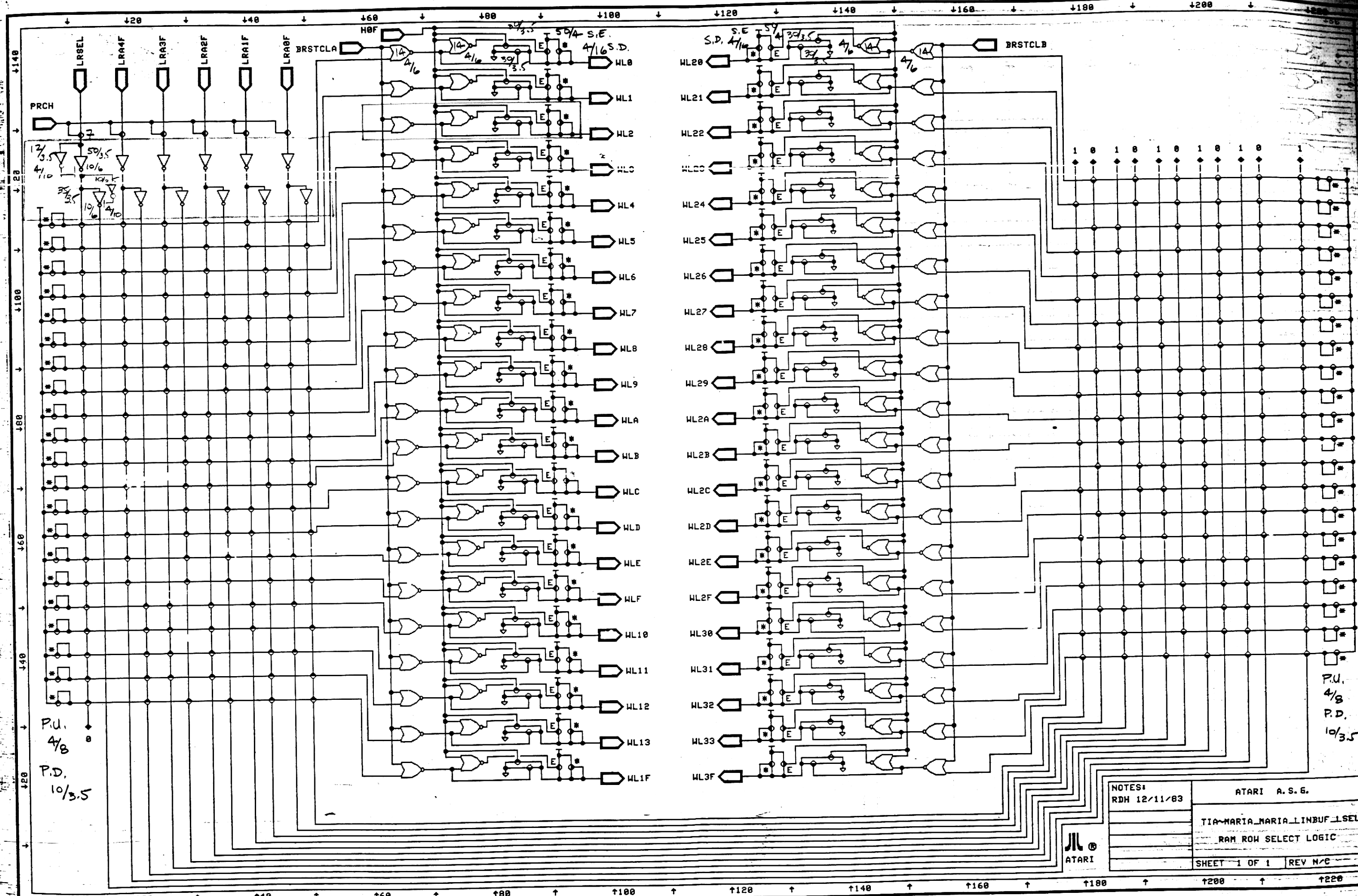

P.U.  
4/8  
P.D.  
10/3.5

P.U.  
4/8  
P.D.  
10/3.5

 ATARI	NOTES: RDH 12/11/83	ATARI A. S. G.
	TIA-MARIA-MARIA_LINBUF_LSEL RAM ROW SELECT LOGIC	
SHEET 1 OF 1		REV N/C



P.U.  
4/8  
P.D.  
10/3.5

P.U.  
4/8  
P.D.  
10/3.5

NOTES: RDH 12/11/83	ATARI A.S.G.
	TIA-MARIA_MARIA_LINBUF_LSEL RAM ROW SELECT LOGIC
SHEET 1 OF 1	REV N/C



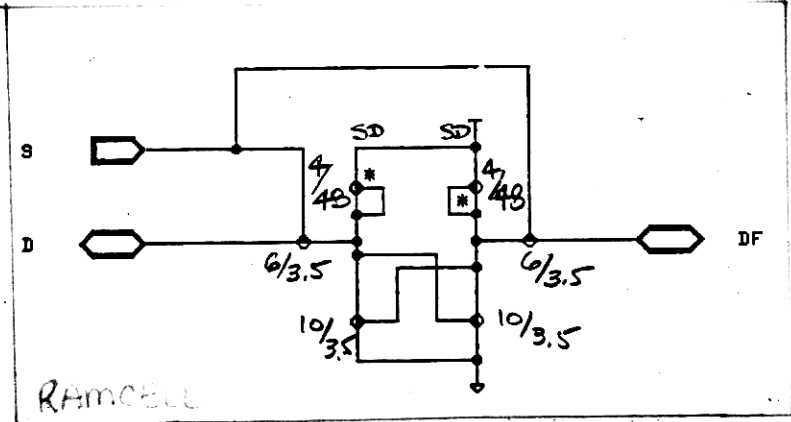
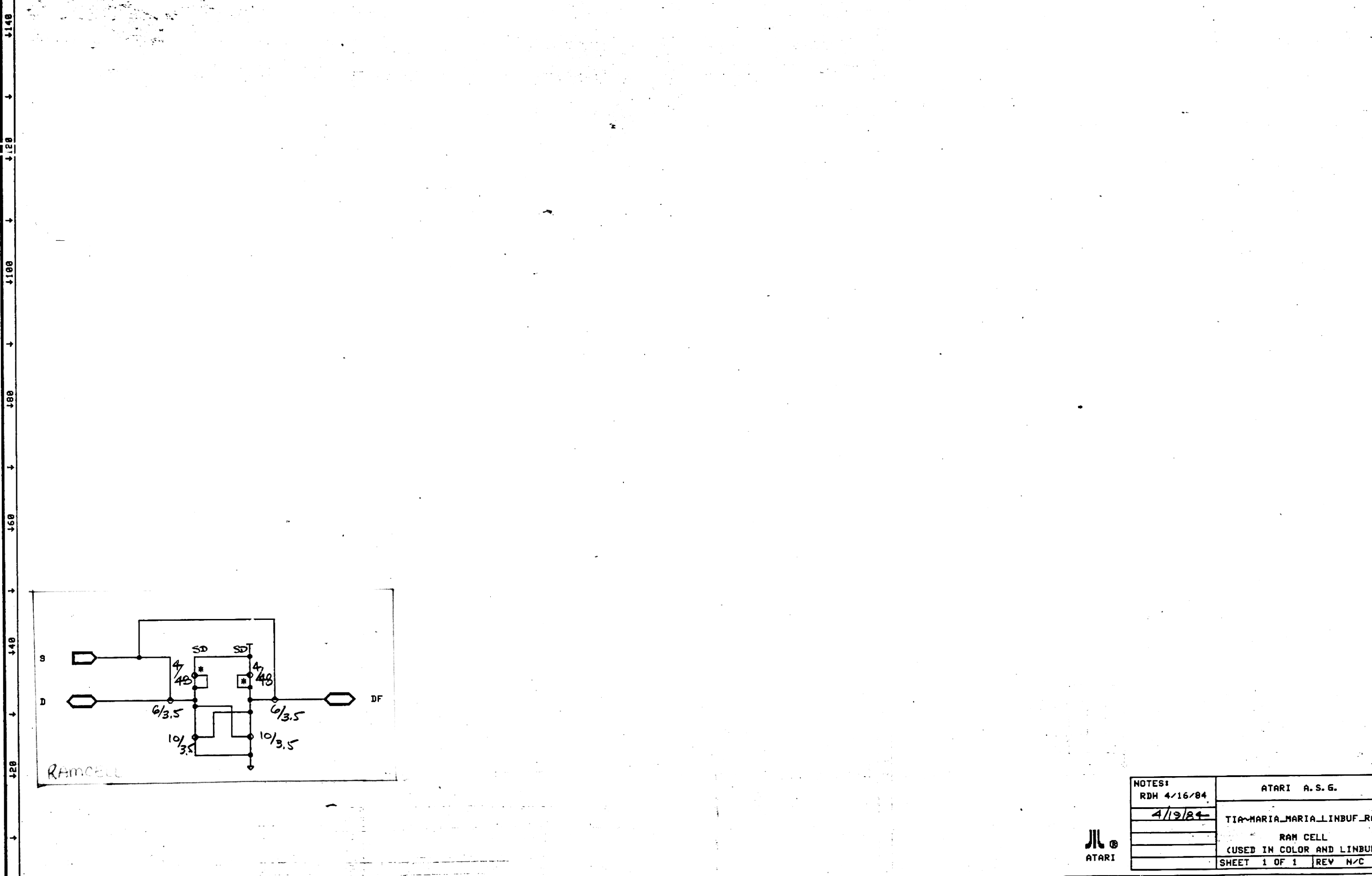

NOTES: RDH 4/16/84 4/19/84	ATARI A.S.G. TIA-MARIA-MARIA-LINBUF-RAM RAM CELL (USED IN COLOR AND LINBUF) SHEET 1 OF 1 REV N/C
----------------------------------	--

16 APR 84 17:18 USER:RDH/TIA-MARIA-MARIA-LINBUF-RAM 1 JUPAN

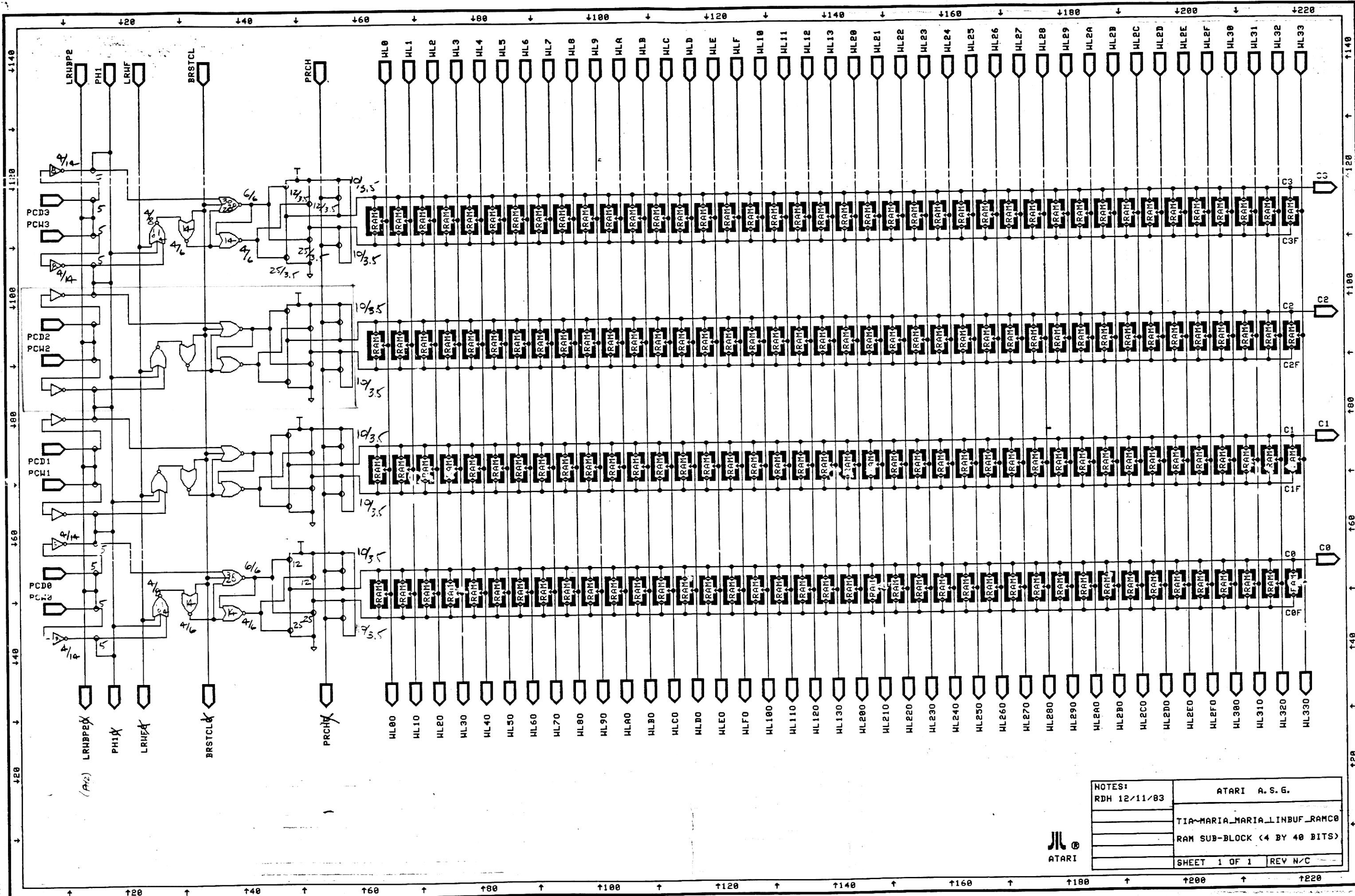

NOTES: RDH 12/11/83	ATARI A. S. G.
	TIA-MARIA_MARIA_LINBUF_RAMC0
	RAM SUB-BLOCK (4 BY 40 BITS)
	SHEET 1 OF 1 REV N/C



ATARI

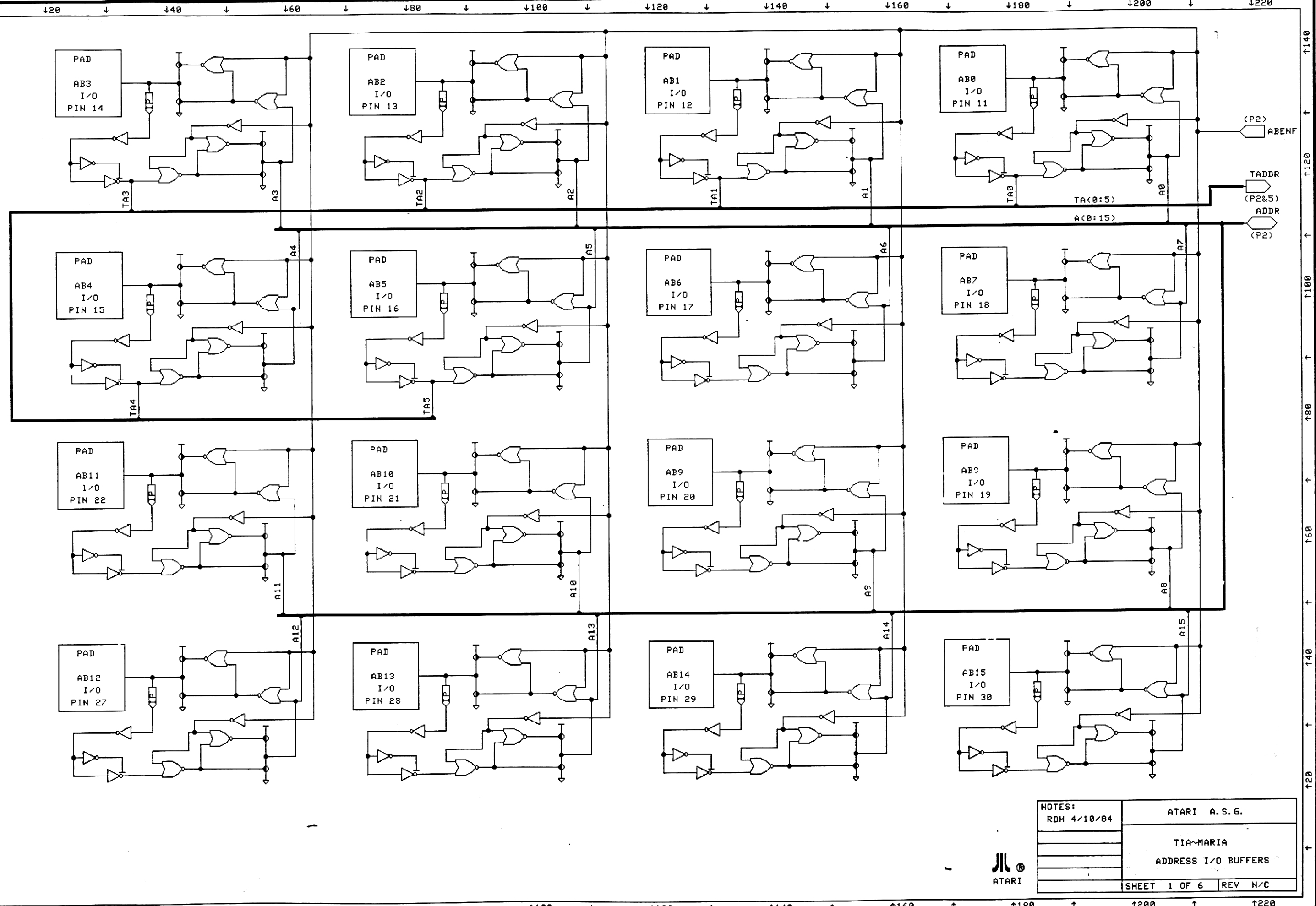

NOTES:	ATARI A.S.G.
RDH 4/10/84	TIA-MARIA
	ADDRESS I/O BUFFERS
	SHEET 1 OF 6
	REV N/C



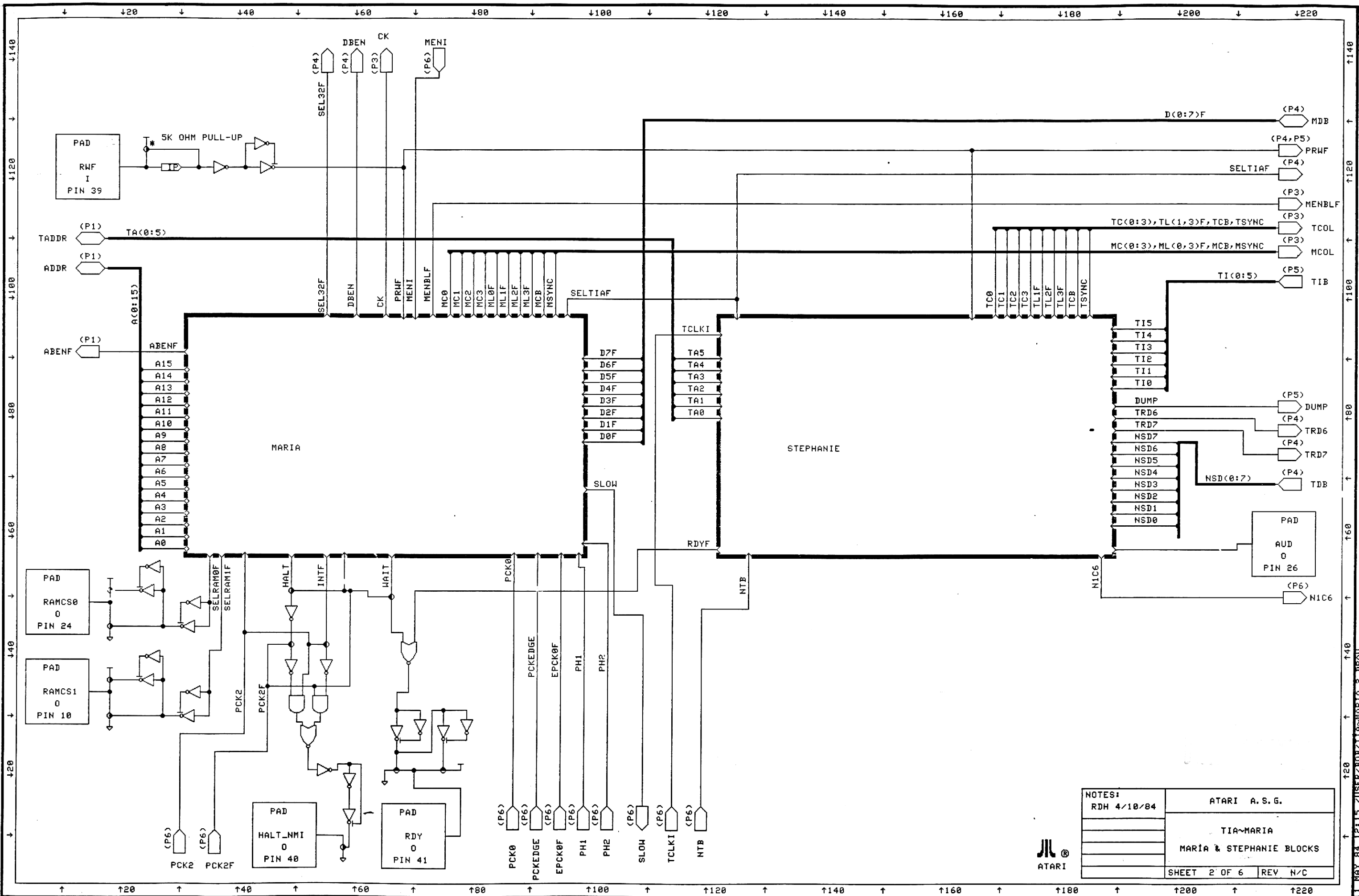

NOTES: RDH 4/10/84	ATARI A. S. G.
	TIA~MARIA MARIA & STEPHANIE BLOCKS
SHEET 2 OF 6	REV N/C



11 MAY 84 12:15 USER:BOB/TIA~MARIA 2.DRAW

\* NOTE: R1,R2 6 MICRON WIDE  
 R1= 274 SQR OR 1480 MICRO  
 R2= 109.5 SQR OR 591 MICRO  
 C1= 11.8 PF OR 17013 SQ MICRO  
 C2= 4.5 PF OR 6512 SQ MICRO

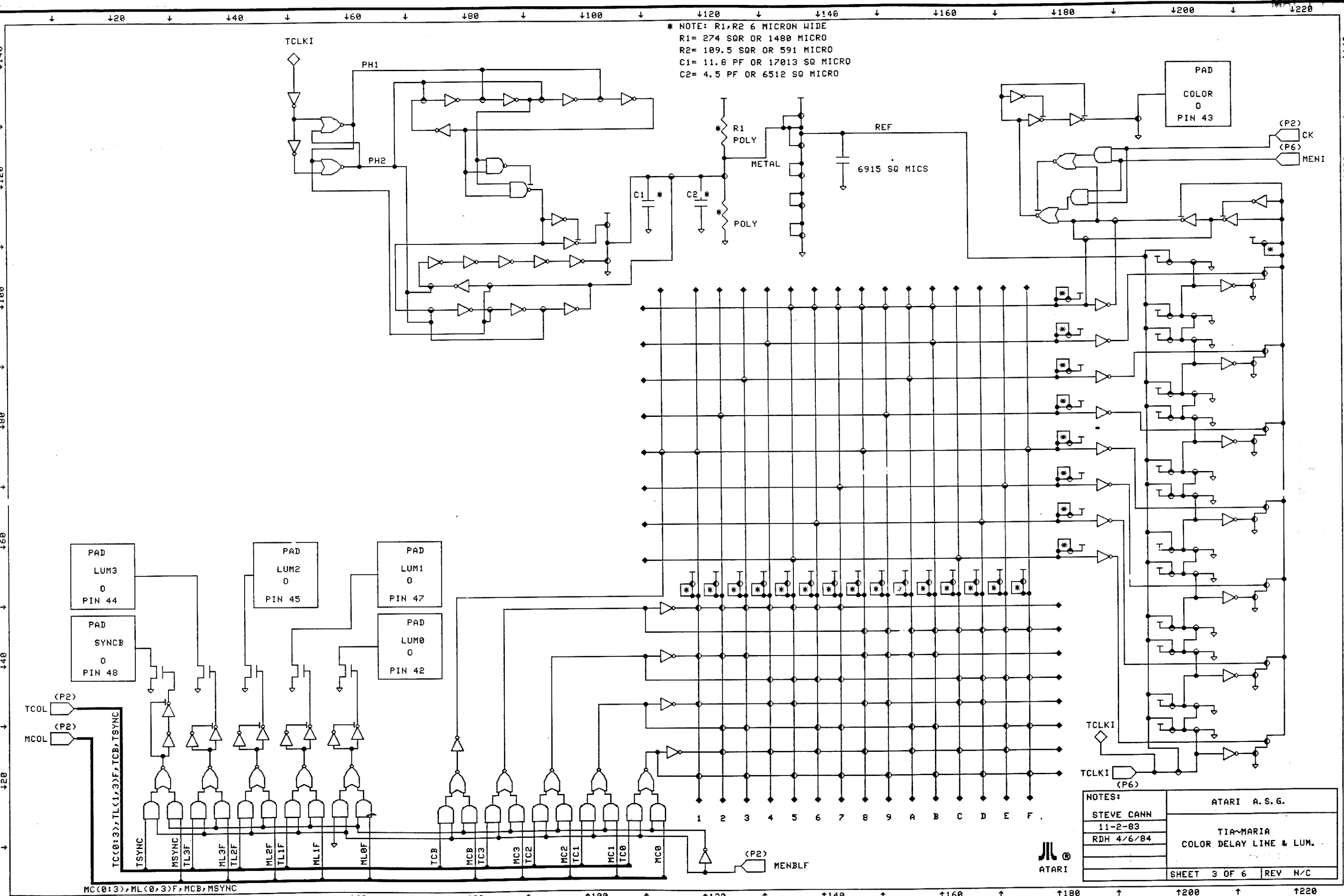

NOTES:		ATARI A.S.G.	
STEVE CANN		TIA-MARIA	
11-2-83		COLOR DELAY LINE & LUM.	
RDH 4/6/84		SHEET 3 OF 6	
		REV N/C	



16 MAY 84 1913Z 70SER/BOB/TIA-MARIA 3-DRAW

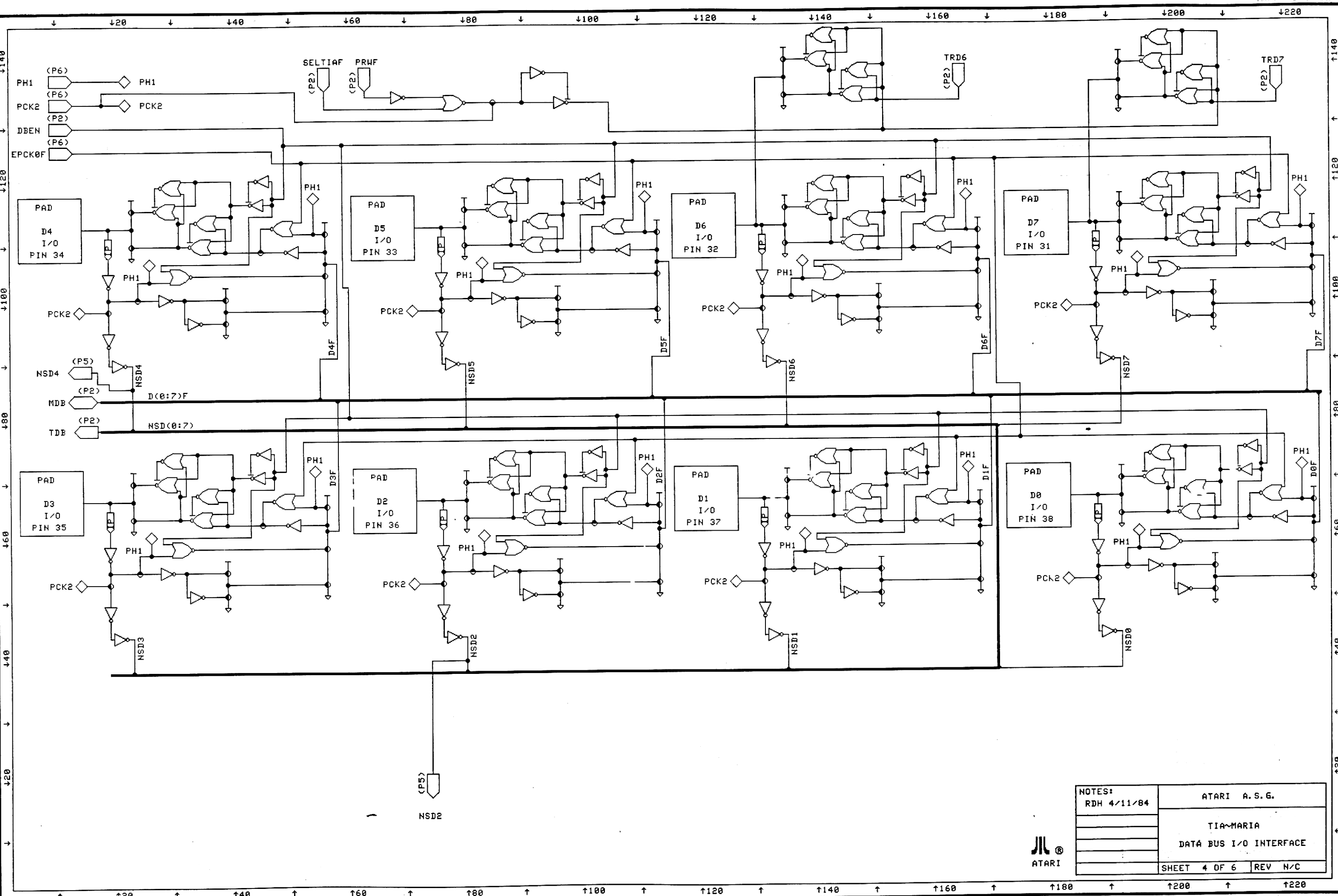

NOTES: RDH 4/11/84	ATARI A. S. G.	
	TIA-MARIA DATA BUS I/O INTERFACE	
	SHEET 4 OF 6	REV N/C



11 MAY 84 12:18 / USER:BOB/TIA-MARIA 4. DRAM



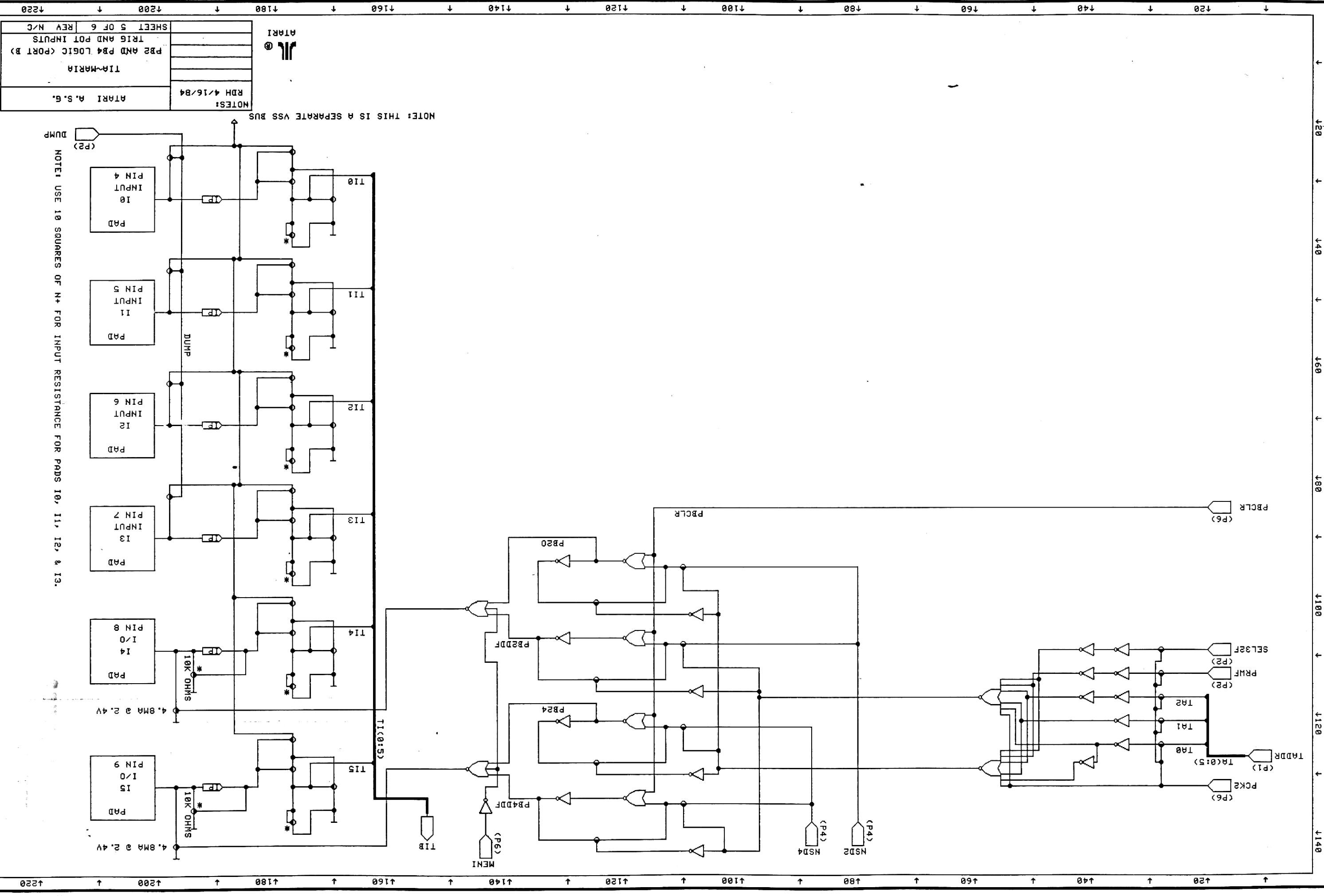

NOTES:	RDH 4/16/84
ATARI A.S.G.	
TIA-MARIA	
PB2 AND PB4 LOGIC (PORT B)	
TRIG AND POT INPUTS	
SHEET 5 OF 6	REV N/C

NOTE: THIS IS A SEPARATE VSS BUS

NOTE: USE 10 SQUARES OF N+ FOR INPUT RESISTANCE FOR PADS 10, 11, 12, & 13.

1 MAY 84 12:19 USER:ZOB/TIA-MARIA S. DRAM

MAY 1984

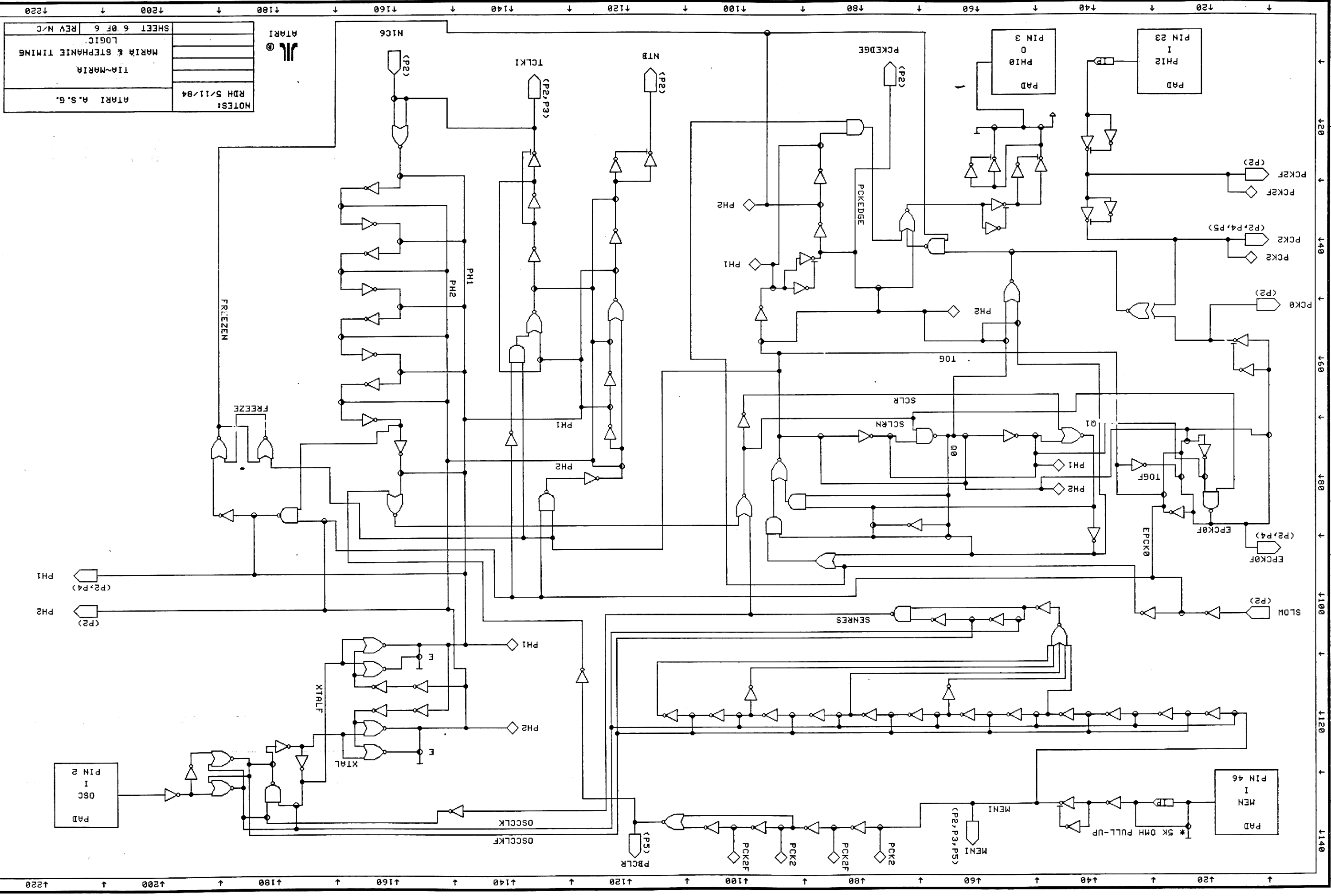

NOTES:	RDH 5/11/84
TIA-MARIA	
MARIA & STEPHANIE TIMING LOGIC	
SHEET 6 OF 6	REV N/C



ATARI A.S.G.

1 MAY 84 12:20 / USER / BOB / TIA-MARIA 5.25IN

1200 1200 1180 1160 1140 1120 1100 1080 1060 1040 1020 1000 980 960 940 920 900 880 860 840 820 800 780 760 740 720 700 680 660 640 620 600 580 560 540 520 500 480 460 440 420 400 380 360 340 320 300 280 260 240 220 200 180 160 140 120 100 80 60 40 20